

SQ, SQE, SQE-NE, CU331SP



1. Product introduction	3	11. CU331SP variable frequency drive	37
Features and benefits	3	Features	37
Identification	5	Applications	37
2. Applications	6	System components	37
SQ with pressure switch and pressure tank	6	Identification	38
Constant-pressure control with		CU331SP product range	39
CU 301 - residential water supply	7	CU331SP performance range	39
Constant-pressure control with		CU331SP sizing	39
CU 301 - irrigation	8	CU331SP operation	40
Maintaining a constant water table	9	CU331SP installation	44
Emptying or filling a tank	10	CU331SP electrical connection	45
Pumping from one tank to another	11	CU331SP technical data	51
Setting of operating parameters	12	CU331SP curve charts	53
SQE with manual speed control	13	12. Accessories	59
3. Performance range	14	CU331SP Constant Pressure	
4. Installation	15	Drive Kits (with sensor)	59
5. Sizing and selection	16	CU 301 Constant Pressure System	59
System sizing guide	16	CU 300 Status Box & R100	59
6. Cable sizing	17	SQ, SQE flow sleeves	59
Cable sizing chart	17	13. Further product documentation	60
7. SQ curve charts	18	WebCAPS	60
5 SQ, SQE	18	WinCAPS	61
10 SQ, SQE	19		
15 SQ, SQE	20		
22 SQ, SQE	21		
30 SQ, SQE	22		
10 SQE-NE	23		
22 SQE-NE	24		
8. Technical data	25		
Electrical data	25		
Operating conditions	25		
Motor data	26		
Dimensions and weights	27		
9. Construction	28		
Materials of construction	28		
Material specification	29		
10. Control units	30		
CU 301	30		
CU 300	33		

1. Product introduction

3-inch SQ, SQE submersible well pumps for 3-inch and larger wells

SQ, SQE pumps are suitable for both continuous and intermittent operation for a variety of applications:

- Domestic water supply
- light commercial
- irrigation
- tank applications.

Features and benefits

SQ, SQE pumps offer these features:

- Dry-run protection
- high efficiency pump and motor
- protection against up-thrust
- soft-start
- over-voltage and under-voltage protection
- over-temperature protection
- high starting torque.

Additionally, SQE pumps offer these advantages:

- Constant pressure control
- variable speed
- electronic control and communication.

SQ, SQE innovative motor technology

SQ, SQE pumps feature an innovative motor design incorporating permanent-magnet technology. By combining permanent-magnet motors and a Grundfos micro-frequency converter, we are able to deliver unmatched performance and the ability to control and communicate with the pump in ways never before possible. A few of the features that result from this combined technology are Constant Pressure Control, Soft-Start, and Integrated Dry-Run Protection, but these are just a few of the features these pumps offer.

SQ pump models operate at a constant speed much like today's conventional pumps. The difference is that SQ delivers the benefits of an electronically controlled permanent-magnet motor that cannot be achieved with a conventional induction motor.

SQ pumps are available for single-phase power; a simple 2-wire design makes installation easy.

SQE pumps are equipped with a Grundfos "Smart Motor." Like the SQ models, SQE pumps have a high efficiency permanent-magnet motor — but we add the ability to communicate.

The "Smart Motor" communicates via the CU301 status box through the power leads.

It is not necessary to run any additional wires down the well. Communication with the pump provides Constant Pressure Control and the highly useful ability to change the pump performance while the pump is installed in the well. Like the SQ motor, this is also a 2-wire motor designed for single-phase operation.

Dry-running protection

The pumps are protected against dry running. A value of $P_{cut-out}$ ensures cut-out of the pump in case of lack of water in the borehole thus preventing a burnout of the motor.

$P_{cut-out}$ is factory-set both for the SQ and SQE, SQE-NE pumps.

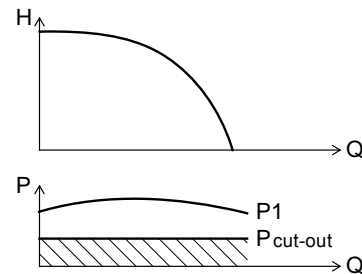

Fig. 1 $P_{cut-out}$ curve

TM01 2751 2298

High pump efficiency

The hydraulic pump components are polyamide reinforced with 30 % glass fiber. The hydraulic design provides for high pump efficiency resulting in low energy consumption and therefore low energy costs.

High motor efficiency

The motors are based on a permanent magnet rotor (PM motor) featuring high efficiency within a wide load range.

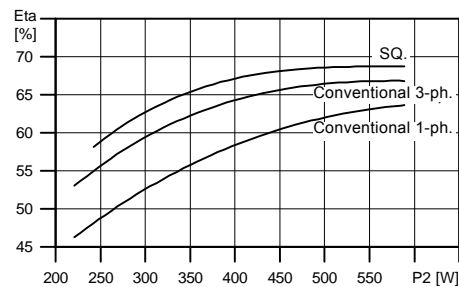

Fig. 2 Efficiency curves of Grundfos SQ motor versus conventional motors

TM01 2698 2298

Wear resistance

The pump design features "floating" impellers (not fastened to the shaft). Each impeller has its own tungsten carbide/ceramic bearing. The construction and materials ensure high wear resistance to sand for long product life.



TM01 3141 3498

Fig. 3 Example of Grundfos floating impeller

Protection against upthrust

Starting up a pump with a very low counter pressure involves the risk of the entire impeller stack being lifted, also called upthrust. Upthrust may cause breakdown of both pump and motor.

SQ, SQE, SQE-NE motors are fitted with a top bearing protecting both pump and motor against upthrust, thus preventing breakdown during the critical start-up phase.

Excellent starting capabilities

The integrated electronic unit of the motor features soft starting. Soft start reduces the starting current and thus gives the pump a smooth and steady acceleration.

The soft starter minimizes the risk of wear on the pump and prevents overloading of the mains during start-up.

The excellent starting capabilities are a result of the high locked-rotor torque of the permanent magnet motor together with the few pump stages. The high starting reliability also applies in case of low voltage supply.

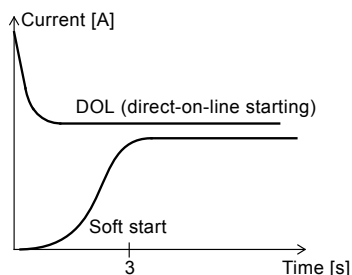

TM01 3479 4198

Fig. 4 Soft-start feature

Overvoltage and undervoltage protection

Overvoltage and undervoltage may occur in case of unstable voltage supply.

The integrated protection of all motors prevents damage to the motor in case the voltage moves outside the permissible voltage range.

The pump will cut out if the voltage falls below 150 V or rises above 315 V. The motor is automatically cut in again when the voltage again falls within the permissible voltage range. Therefore no extra protection relay is needed.

Overload protection

Exposure of the pump to heavy load causes the current consumption to rise. The motor will automatically compensate for this by reducing the speed to 3000 rpm. Further overload will lead to stop.

If the rotor is being prevented from rotating, this will automatically be detected and the power supply will be cut out. Consequently, no extra motor protection is needed.

Overtemperature protection

A permanent magnet motor gives off very little heat to its surroundings. In combination with an efficient internal circulation system leading the heat away from the rotor, stator and bearings, this ensures optimum operating conditions for the motor.

As an extra protection, the electronic unit has a built-in temperature sensor. When the temperature rises too high, the motor is cut out; when the temperature has dropped, the motor is automatically cut in again.

Reliability

The motors are built for high reliability and feature:

- Tungsten carbide / ceramic bearings
- thrust bearings protecting against downthrust
- product life time equal to conventional AC motors.

Variable speed

The SQE motor enables continuously variable speed control from 3,000 to 10,700 rpm. The pump can be set to operate in any duty point in the range between the 3,000 and 10,700 rpm performance curves of the pump. Consequently, the pump performance can be adapted to any specific requirement.

The variable speed control facility requires the use of the CU 300 or CU 301 control unit.

For the calculation of pump speed, the program "SQE Speed Calculation" is available on CD-ROM as an accessory.

Identification

Type key example SQ, SQE, SQE-NE

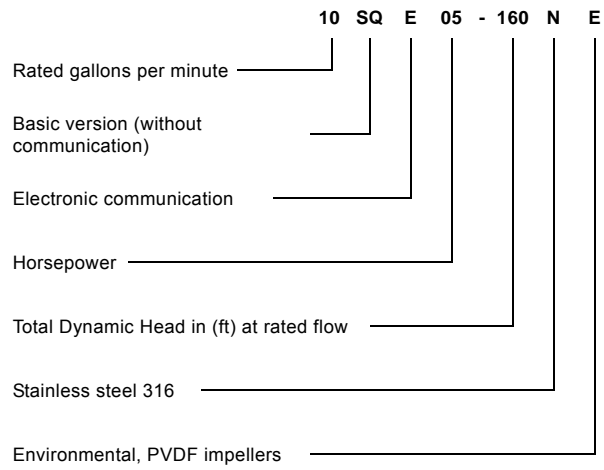

2. Applications

SQ with pressure switch and pressure tank

SQ is ideally suited for domestic water supply in single- family dwellings or summer homes which are not connected to municipal waterworks. SQ is easy to install and operate.

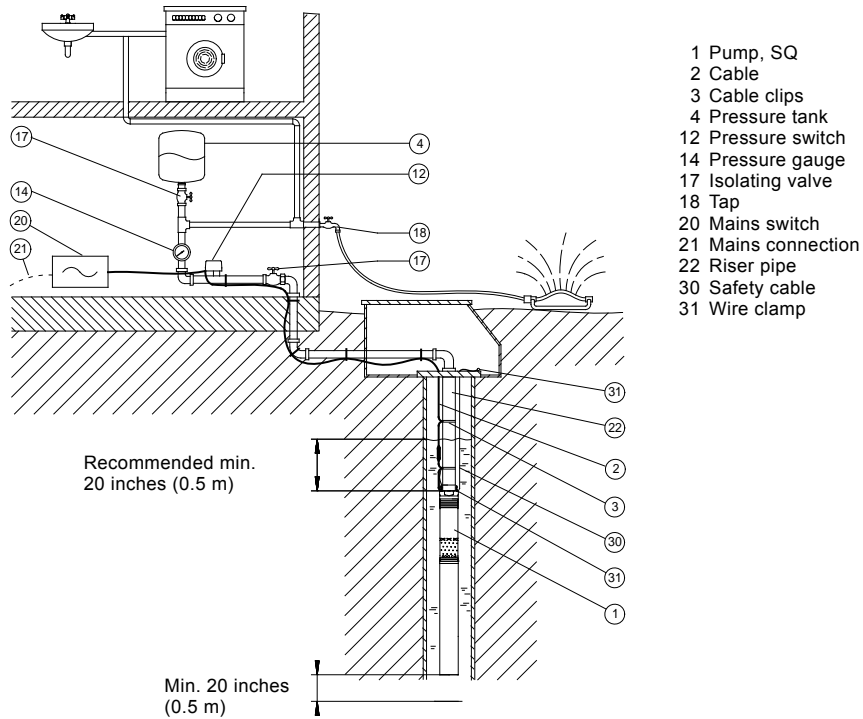

TM01 2447 1798

Fig. 5 Application example: SQ with pressure switch and pressure tank

Pos.	Part	Type	No. of units	Product number	Unit price	Total price
1	Pump	SQ				
2	Cable					
3	Cable clips					
4	Pressure tank					
12	Pressure switch					
14	Pressure gauge					
20	Mains switch					
30	Safety cable					
31	Wire clamp					

Constant-pressure control with CU 301 - residential water supply

The system maintains a constant pressure within the maximum pump performance in spite of a varying water consumption.

The pressure is registered by the pressure sensor and transmitted to the CU 301. The CU 301 adjusts the pump performance accordingly.

Function

When a tap is opened the pressure in the tank will start to drop. At a flow lower than approximately 1 gpm (0.18 m³/h), the pressure will drop slowly.

When the pressure in the tank is 7 psi (0.5 bar) below setpoint, the pump will start. The pump will run until the pressure is 7 psi (0.5 bar) above setpoint. This way of operation is called on/off operation.

At a flow higher than approximately 1 gpm (0.18 m³/h), the pressure will drop quickly and the pump will start immediately and maintain a constant pressure.

During operation, the CU 301 will regulate the pump speed to maintain a constant pressure. If there is no consumption, the pump will boost the pressure to 7 psi (0.5 bar) above setpoint and stop after a few seconds.

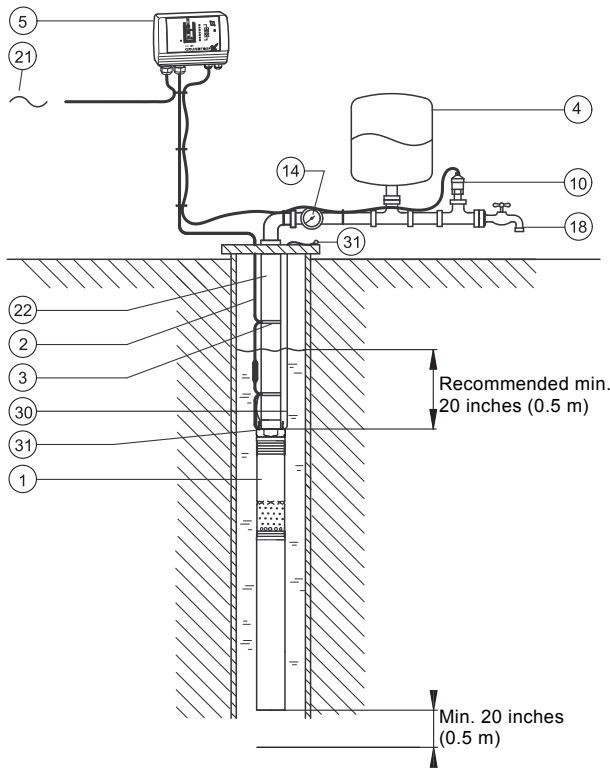

- 1 Pump, SQE
- 2 Cable
- 3 Cable clips
- 4 Pressure tank, 2 gal (8 liters)
- 5 Control unit, CU 301
- 10 Pressure sensor, 0 - 120 psi (0 - 6 bar)
- 14 Pressure gauge
- 18 Tap
- 21 Mains connection
- 22 Riser pipe
- 30 Safety cable
- 31 Wire clamp

Fig. 6 Application example: Constant-pressure control with CU 301 - residential water supply

TM03 3429 0406

Pos.	Part	Type	No. of units	Product number	Unit price	Total price
1	Pump	SQE				
2	Cable					
3	Cable clips					
4	Pressure tank	2 gal (8 liters)				
5	Control unit	CU 301				
10	Pressure sensor	0 - 120 psi (0 - 6 bar)				
14	Pressure gauge					
30	Safety cable					
31	Wire clamp					

Constant-pressure control with CU 301 - irrigation

The system maintains a constant pressure within the maximum pump performance in spite of a varying water consumption.

The pressure is registered by means of the pressure sensor and transmitted to the CU 301. The CU 301 adjusts the pump performance accordingly.

Function

When the sprinkler system is started, the pressure in the tank will start to drop.

At a flow lower than approximately 1 gpm (0.18 m³/h), the pressure will drop slowly. When the pressure in the

tank is 7 psi (0.5 bar) below setpoint, the pump will start. The pump will run until the pressure is 7 psi (0.5 bar) above setpoint. This way of operation is called on/off operation.

At a flow higher than approximately 1 gpm (0.18 m³/h), the pressure will drop quickly and the pump will start immediately and maintain a constant pressure.

During operation, the CU 301 will regulate the pump speed to maintain a constant pressure. If there is no consumption, the pump will boost the pressure to 7 psi (0.5 bar) above setpoint and stop after a few seconds.

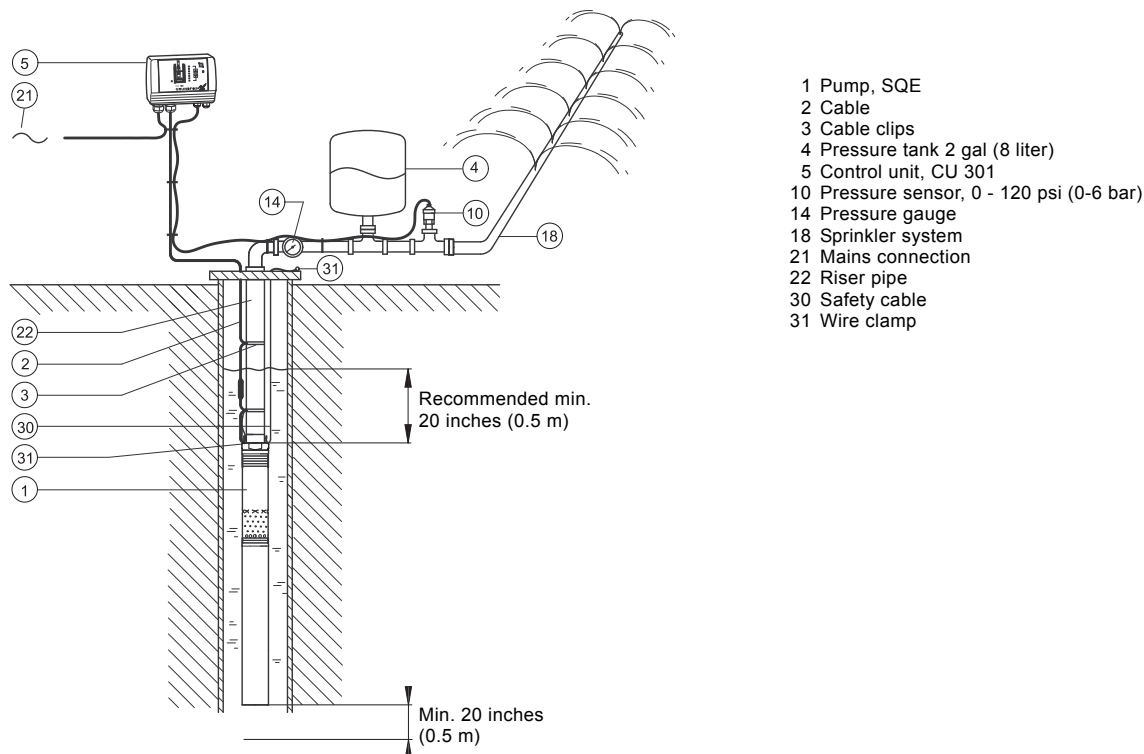

Fig. 7 Application example: Constant-pressure control with CU 301 - irrigation

Pos.	Part	Type	No. of units	Product number	Unit price	Total price
1	Pump	SQE				
2	Cable					
3	Cable clips					
4	Pressure tank	2 gal (8 liter)				
5	Control unit	CU 301				
10	Pressure sensor	0 - 120 psi (0 - 6 bar)				
14	Pressure gauge					
30	Safety cable					
31	Wire clamp					

TIM03 3428 2810

Maintaining a constant water table

A constant water table can be maintained by adjusting pump performance. It may be important to maintain a constant water table, e.g. in connection with keeping out the groundwater on a building site or water remediation projects.

The example shows how to maintain a constant water table by adjusting pump performance.

Sensors

Level	Description	Reaction
Level sensor (pos. 11)		
Warning (max.)	Too high water level. Possible cause: Insufficient pump capacity.	Alarm relay operates.
Desired level	The water level which should be maintained.	
Warning (min.)	Too low water level. Possible cause: Too high pump capacity.	Alarm relay operates.

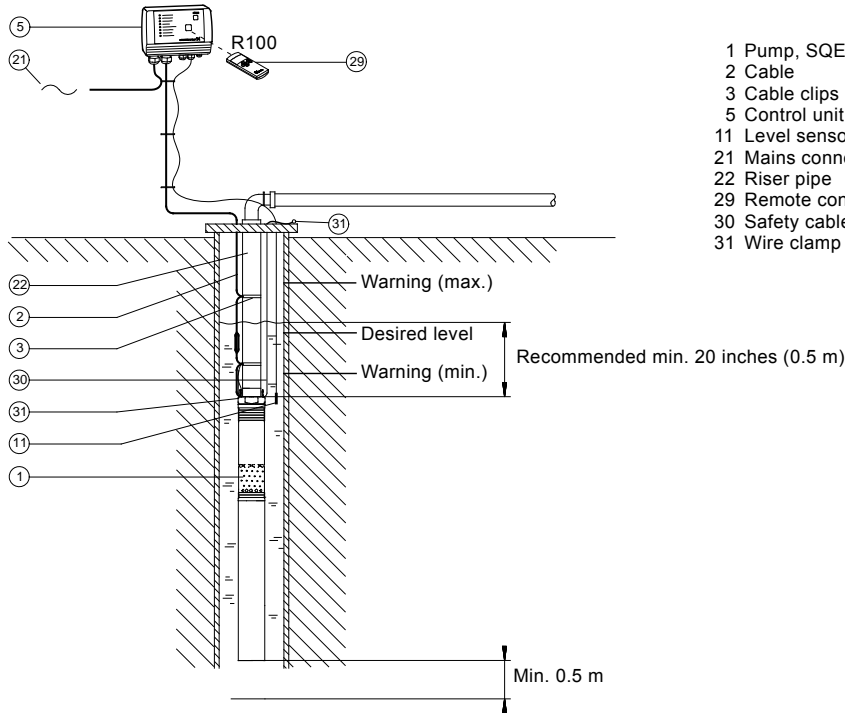

- 1 Pump, SQE
- 2 Cable
- 3 Cable clips
- 5 Control unit, CU 300
- 11 Level sensor
- 21 Mains connection
- 22 Riser pipe
- 29 Remote control, R100
- 30 Safety cable
- 31 Wire clamp

Fig. 8 Application example: Maintaining a constant water table

TM01 2459 2810

Pos.	Part	Type	No. of units	Product number	Unit price	Total price
1	Pump	SQE				
2	Cable					
3	Cable clips					
5	Control unit	CU 300				
11	Level sensor					
29	Remote control	R100				
30	Safety cable					
31	Wire clamp					

Emptying or filling a tank

The SQE pump with CU 300 is ideal for emptying or filling a tank.

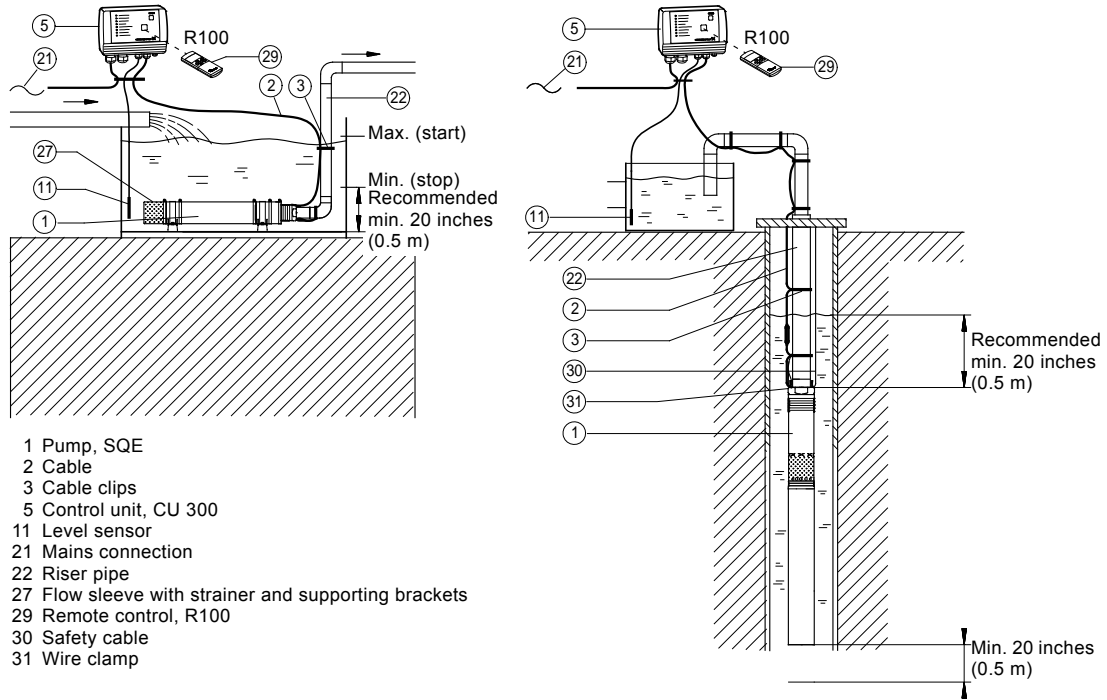

Fig. 9 Application example: Emptying or filling a tank

Pos.	Part	Type	No. of units	Product number	Unit price	Total price
1	Pump	SQE				
2	Cable					
3	Cable clips					
5	Control unit	CU 300				
11	Level sensor					
22	Riser pipe					
27	Flow sleeve with strainer and supporting brackets					
29	Remote control	R100				
30	Safety cable					
31	Wire clamp					

Pumping from one tank to another

The SQE pump is ideal for pumping water from one tank to another.

Sensors

Level	Description	Light indication on CU 300
Level sensor (pos. 11, tank at top)		
Max. (stop)	When the water has reached this level, the pump stops.	Green indicator light in on/off button is flashing.
Min. (start)	When the water has dropped to this level, the pump starts.	Green indicator light in on/off button is permanently on.
Level sensor (pos. 11, tank at bottom)		
Max. (start)	When the water has reached this level, the pump starts.	Green indicator light in on/off button is on.
Min. (stop)	When the water has dropped to this level, the pump stops.	Green indicator light in on/off button is flashing.

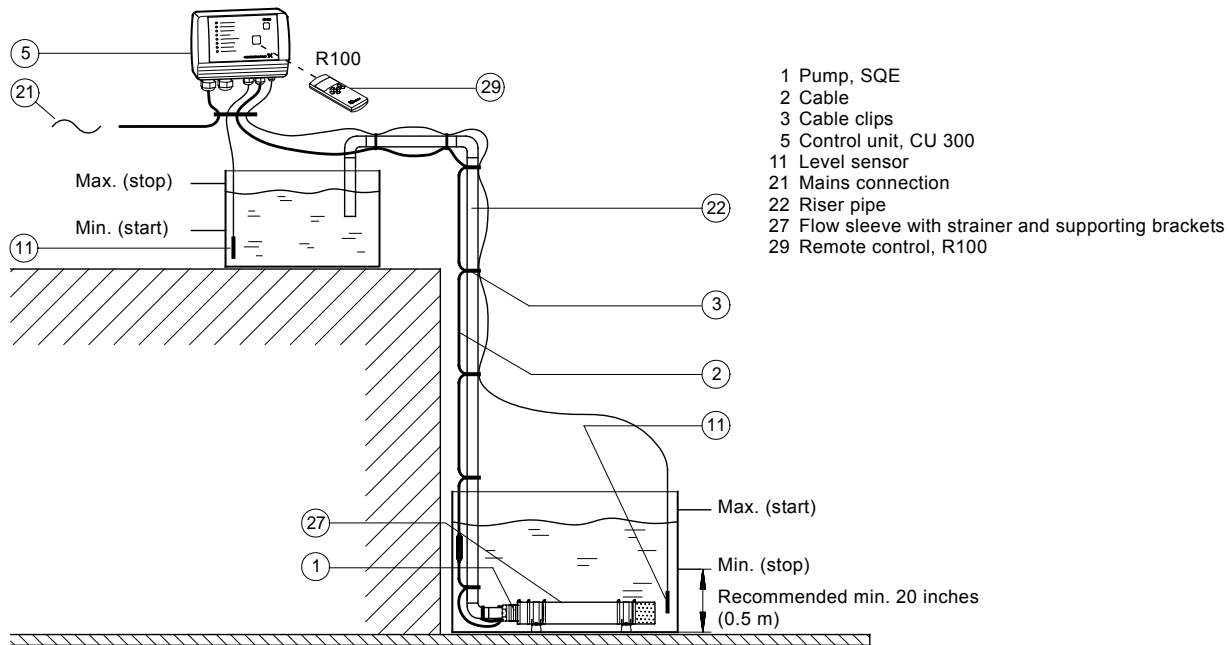

Fig. 10 Application example: Pumping from one tank to another

TM01 2454 4801

Pos.	Part	Type	No. of units	Product number	Unit price	Total price
1	Pump	SQE				
2	Cable					
3	Cable clips					
5	Control unit	CU 300				
11	Level sensor					
27	Flow sleeve with strainer and supporting brackets					
29	Remote control	R100				

Setting of operating parameters

Using the R100 and the CU 300 enables change of the motor speed and thereby setting of the pump to a specific performance.

The software program "SQE Speed Calculation" has been developed for the calculation of the speed in order to obtain the required flow rate and head.

Dry-running protection

The value $P_{\text{cut-out}}$, ensuring dry-running protection, is factory-set for the SQE pump.

If the speed of the SQE pump is reduced by more than 1000 rpm, the $P_{\text{cut-out}}$ value must be readjusted by means of the CU 300 and R100.

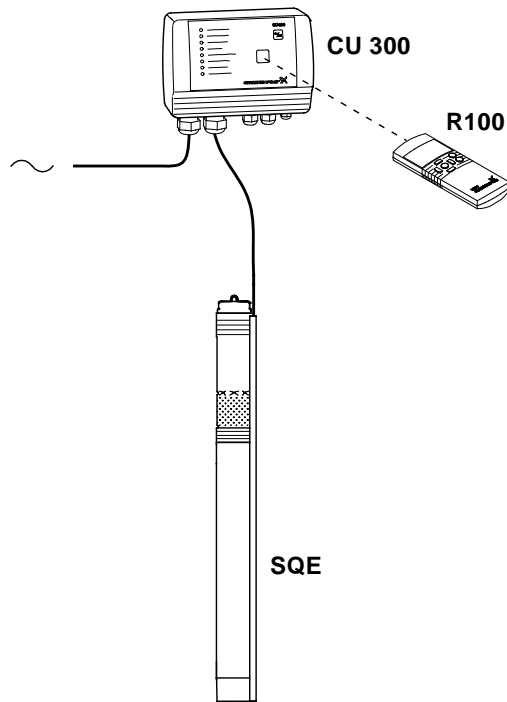

Note: The SQE pump must not be started until the pump has been completely submerged below the water table. However, the change of the motor speed can be made even if the pump is not submerged.

Fig. 11 Application example: Workshop setting of operating parameters

Part	Type	No. of units	Product number	Unit price	Total price
Pump	SQE				
Remote control	R100				
Control unit	CU 300				
SQE Speed Calculation program					

TM01 8650 4801

SQE with manual speed control

Functioning and benefits

Manual speed control of the SQE pumps is possible by means of R100 and an SPP 1 potentiometer.

This application is especially suitable for sampling from groundwater monitoring wells. The monitoring well is purged at high speed and the sample is taken at a low speed (quiet flow). For contaminated groundwater the SQE-NE type range is recommended.

In case frequent sampling is required, dedicated installation of the pump is recommended, thus eliminating wear caused by frequent assembly and dismantling the installation.

Furthermore, dedicated installations saves the costs of assembling and dismantling the installation.

Important: Through dedicated installation the transfer of contamination from one monitoring well to another is avoided.

Dry-running protection

The value $P_{\text{cut out}}$, ensuring dry-running protection, is factory-set for the SQE pump. If the speed of the pump is reduced more than 1,000 rpm, the value of $P_{\text{cut out}}$ must be readjusted by means of CU 300 and R100.

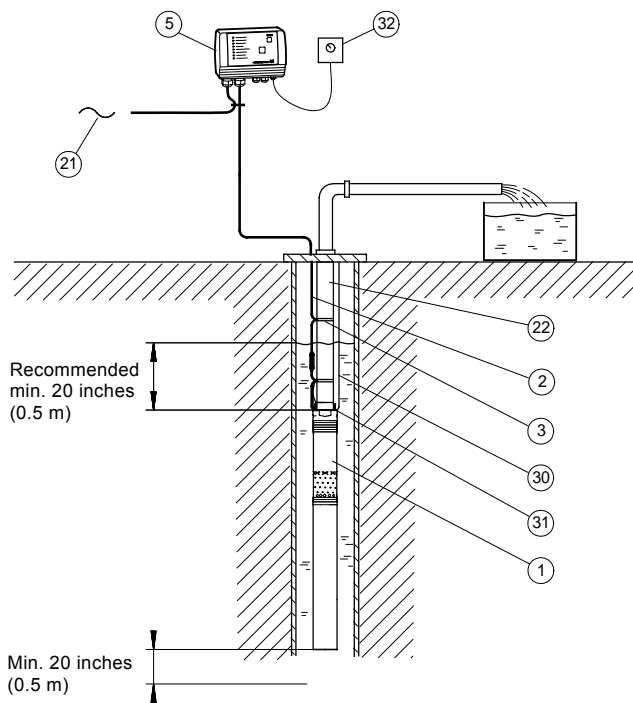

- 1 SQE pump
- 2 Cable
- 3 Cable clips
- 5 Control unit, CU 300
- 21 Mains connection
- 22 Riser pipe
- 30 Stainless-steel safety cable
- 31 Stainless-steel wire clamps, 2 per lifting eye
- 32 Potentiometer, SPP 1

Fig. 12 Application example: Sampling/manual speed control of SQE

TM01 9028 4801

Pos.	Part	Type	No. of units	Product number	Unit price	Total price
1	Pump	SQE				
2	Cable					
3	Cable clips					
5	Control unit	CU 300				
22	Riser pipe					
30	Stainless-steel safety cable					
31	Wire clamps	2 per lifting eye				
32	Potentiometer	SPP 1				

3. Performance range

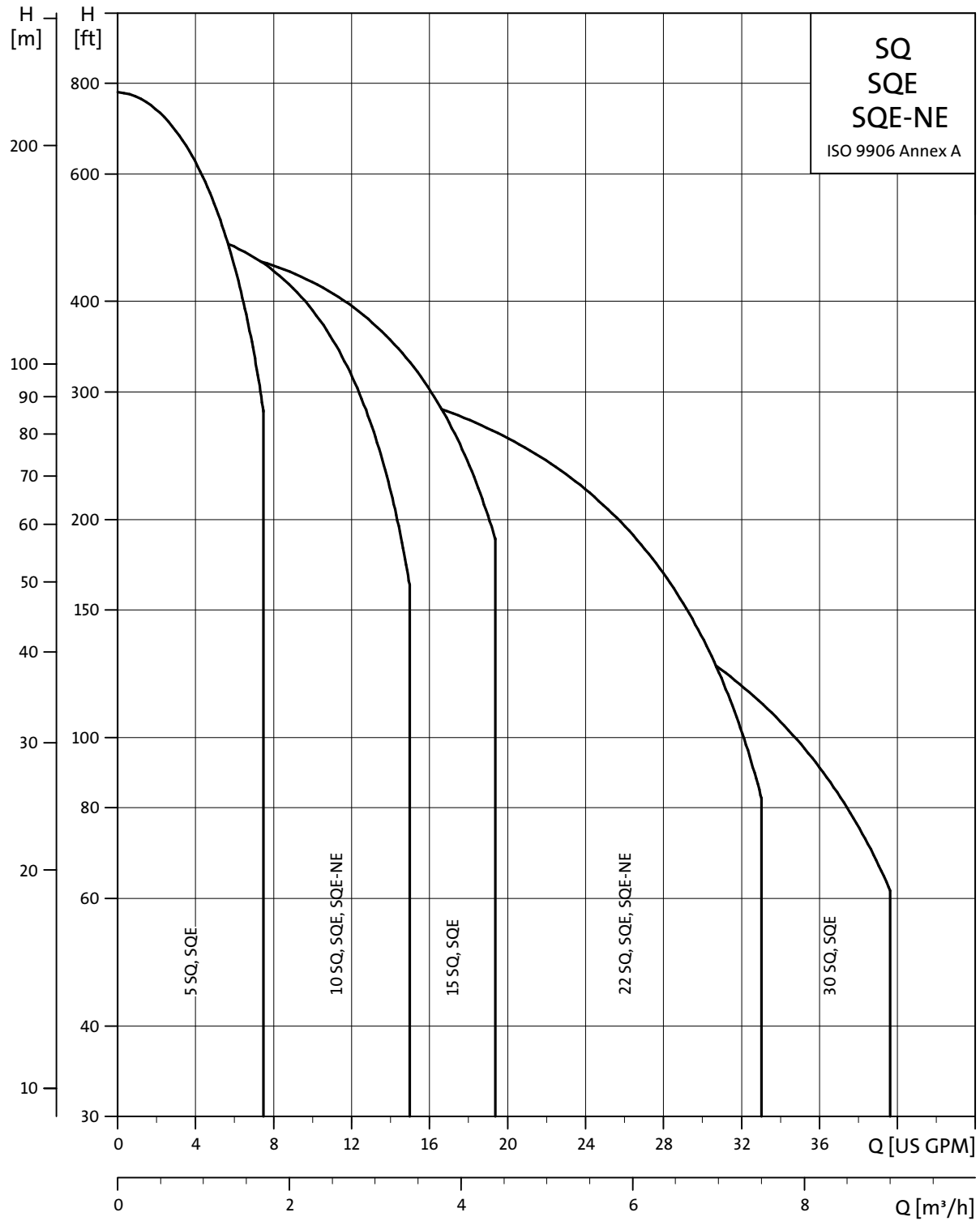

TM02 9975 2010

4. Installation

The SQ and SQE, SQE-NE may be installed vertically, horizontally or in any position in between.

Note: The pump must not fall below the horizontal level in relation to the motor.

The following features ensure simple installation of the pump:

- Built-in check valve with spring
- low weight ensuring user-friendly handling
- installation in 3" or larger boreholes
- only on/off switch is needed, which means that no extra motor starter / starter box is necessary.

For horizontal installation a flow sleeve is recommended in order to:

- ensure sufficient flow velocity past the motor and thus provide sufficient cooling
- prevent motor and electronic unit from being buried in sand or mud.

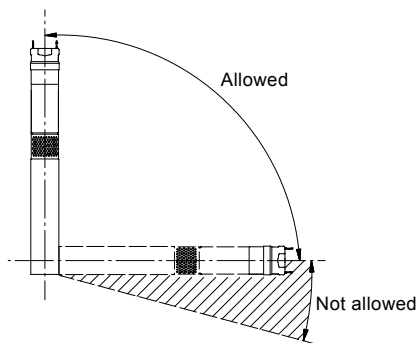

TM01 1375 1498

Fig. 13 SQE installation

5. Sizing and selection

System sizing guide

Step 1

Calculate minimum head requirements at no flow conditions:

$$H_{\max} \text{ (required)} = \text{dynamic head} + \text{system pressure (in feet)} + \text{above grade elevation} + \text{friction loss}$$

Step 2

Select pump from chart as follows:

- Choose model family based on the desired flow rate (i.e. 15SQE for a flow rate of 15 gpm)
- Select the first model with a value in Column 2 greater than the H_{\max} calculated in Step 1 (For example: the choice for a 22 gpm model with an H_{\max} of 140 ft would be the 22SQE-160).
- Double check your selection in the performance curves; see [7. SQ curve charts](#) on p. 18.

System sizing matrix		
Pump type Model B	Column 1	Column 2
	Shutoff head (0 gpm) @ 3000 rpm min. speed	Head @ rated gpm @ 10700 rpm max. speed
	TDH [feet]	TDH [feet]
5SQE-90	11	86
5SQE-140	17	131
5SQE-180	22	177
5SQE-230	28	222
5SQE-270	34	270
5SQE-320	39	315
5SQE-360	45	360
5SQE-410	51	405
5SQE-450	56	450
10SQE-110	12	105
10SQE-160	17	164
10SQE-200	23	215
10SQE-240	29	267
10SQE-290	34	328
10SQE-330	40	390
15SQE-70	10	75
15SQE-110	14	123
15SQE-150	19	164
15SQE-180	24	205
15SQE-220	29	246
15SQE-250	33	287
15SQE-290	38	328
22SQE-40	5	36
22SQE-80	9	77
22SQE-120	14	117
22SQE-160	18	159
22SQE-190	23	200
22SQE-220	27	240
30SQE-40	5	33
30SQE-90	11	82
30SQE-130	16	126

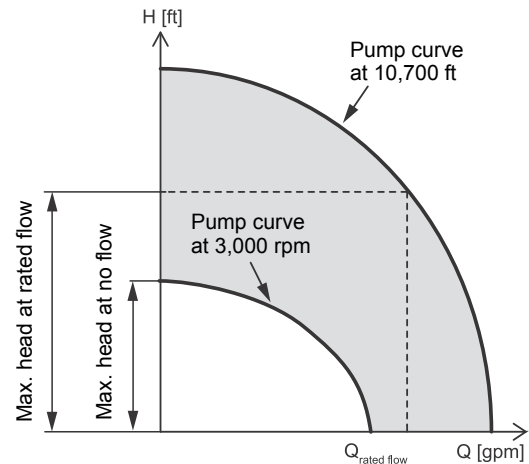

Fig. 14 Recommended sizing

Note: All calculated head requirements must lie between the selected pump models minimum and maximum speed curves.

TM01 8547 0400

6. Cable sizing

Cable sizing chart

Motor rating			Copper wire size (AWG)						
Volts	Hp	Amps	14	12	10	8	6	4	2
115	0.5	12	140	220	360	550	880	1390	2260
230	0.5	5.2	640	1000	1660	2250	4060	—	—
230	0.75	8.4	400	620	1030	1580	2510	3970	—
230	1	11.2	300	460	770	1190	1890	2980	4850
230	1.5	12	280	430	720	1110	1760	2780	4530

Cable length in feet.

Note: shaded values do not apply when using a CU 301 as its max. recommended cable length is 650 ft.

7. SQ curve charts

5 SQ, SQE

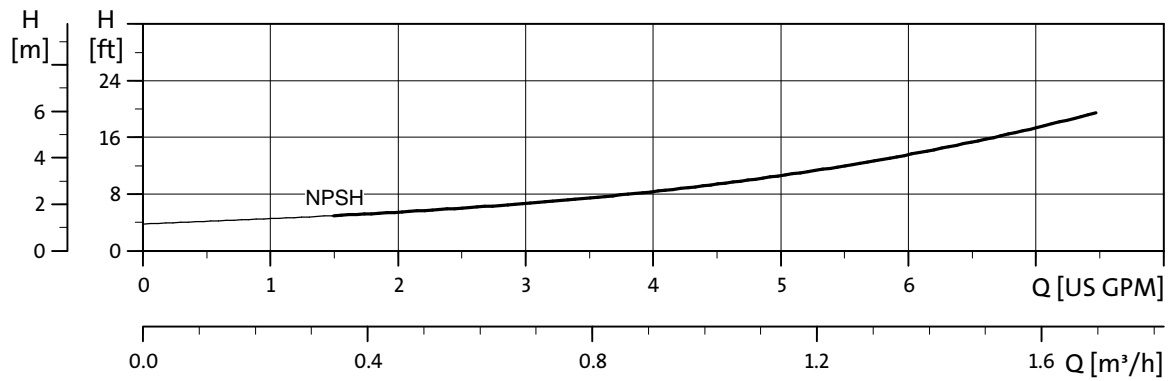
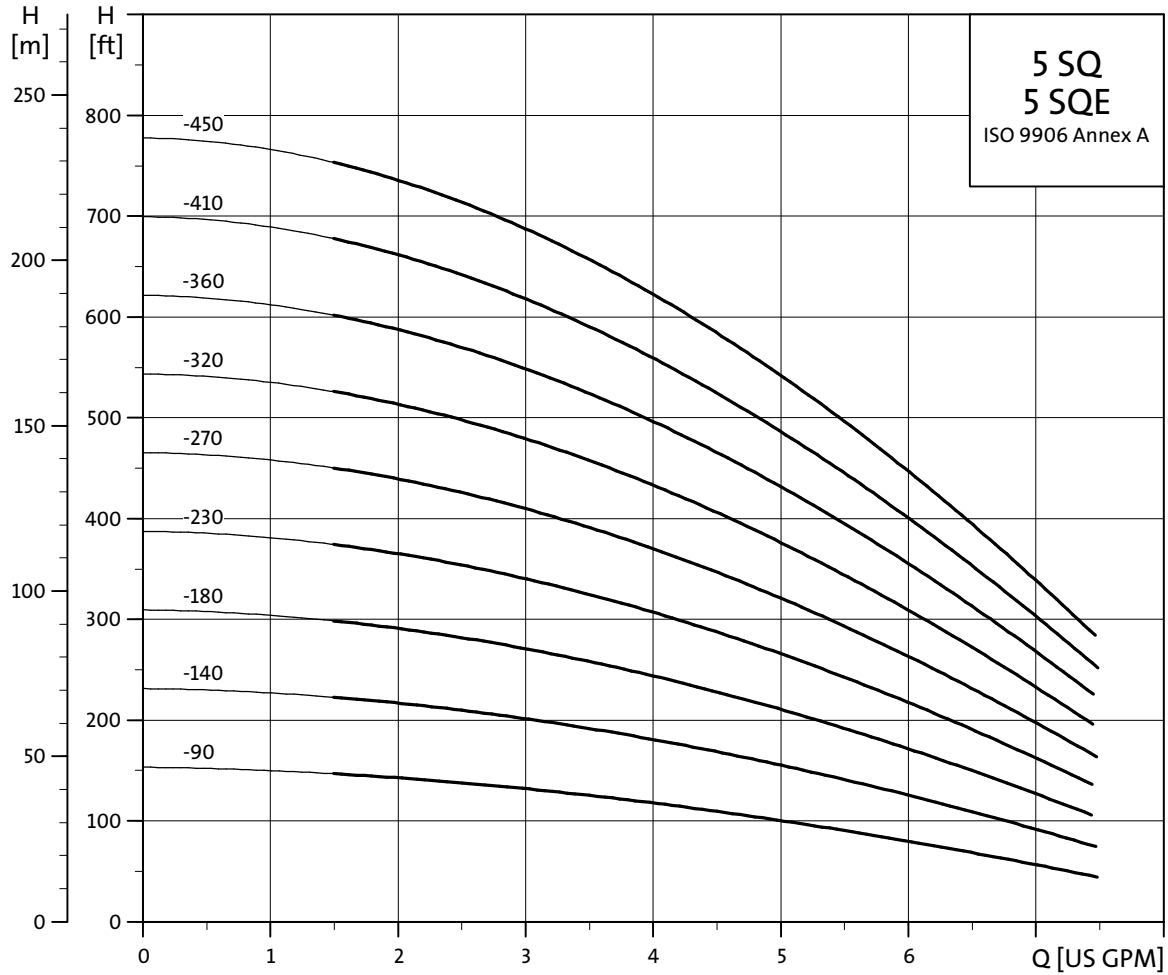

TM04 7463 2010

10 SQ, SQE

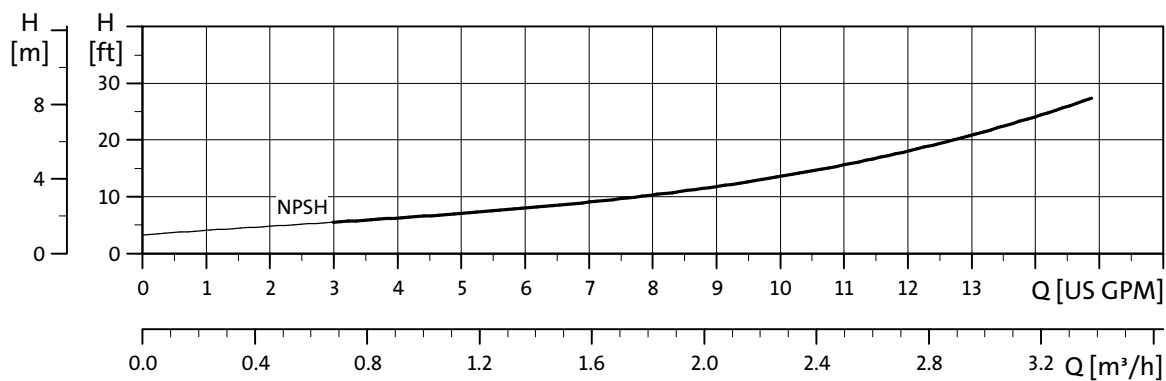
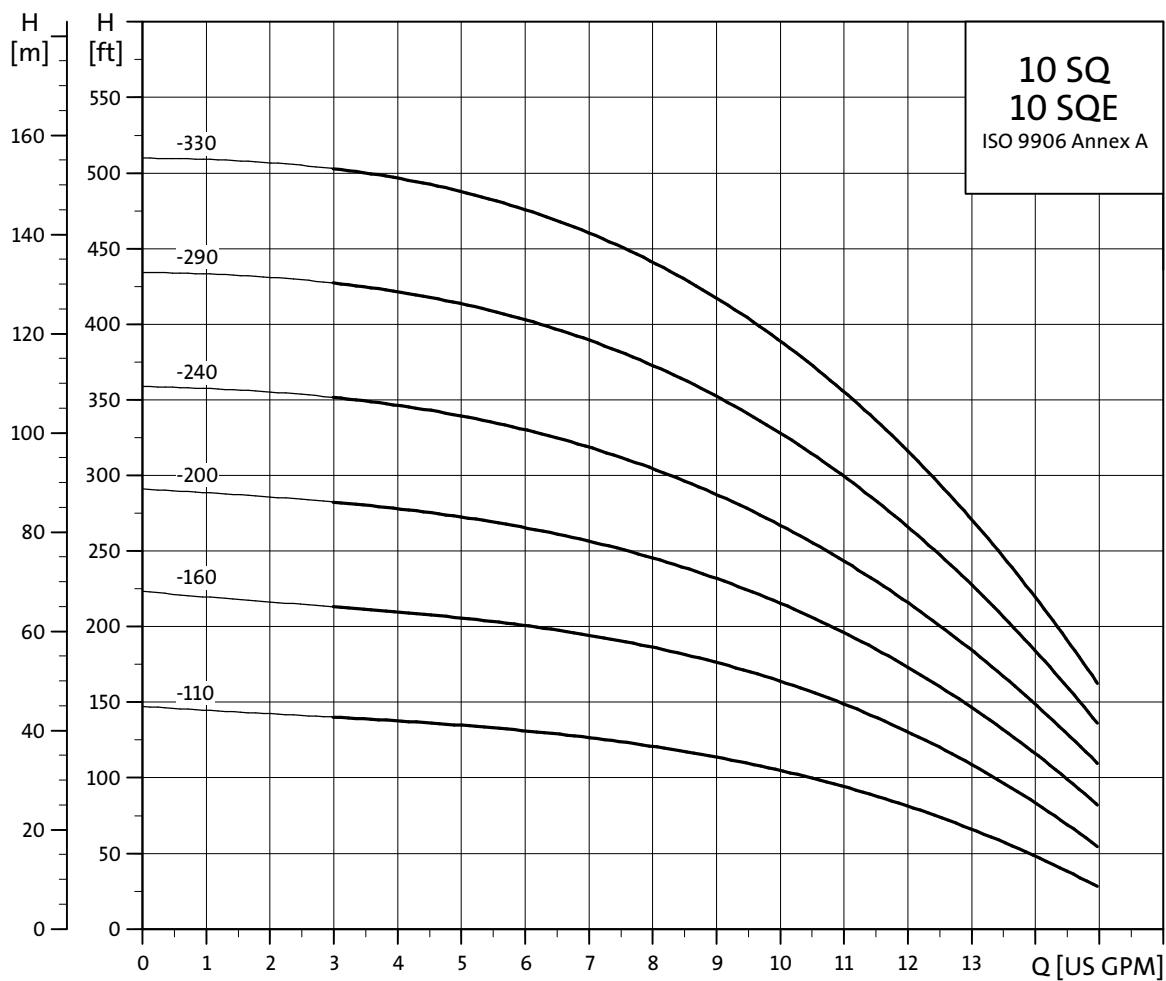

TM04 7464 2010

15 SQ, SQE

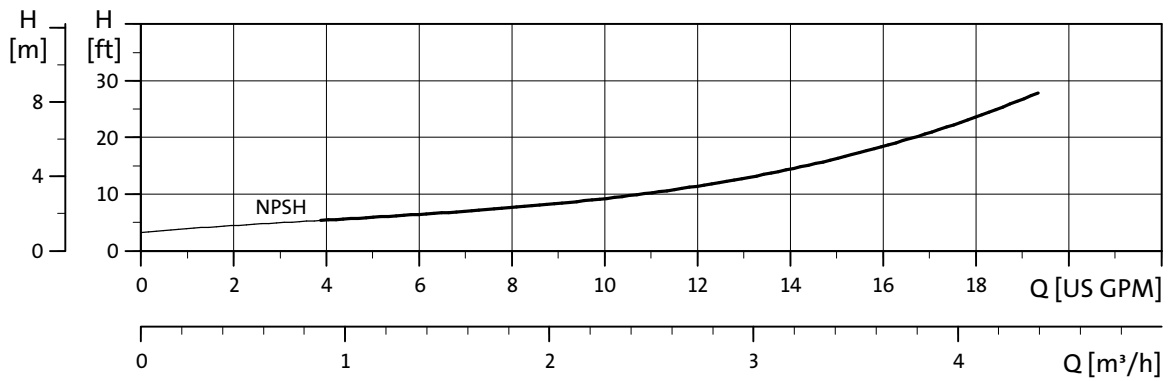
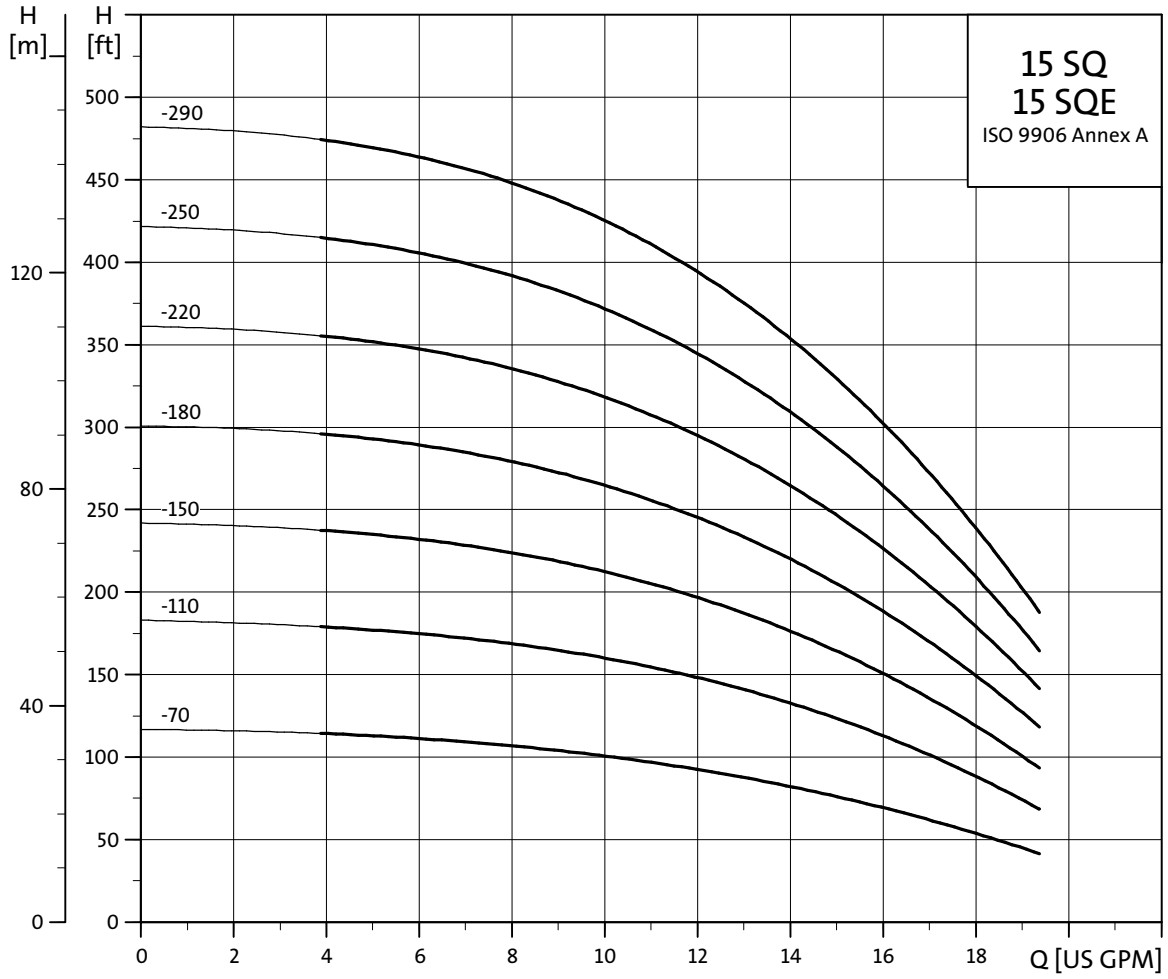

TM04 7465 2010

22 SQ, SQE

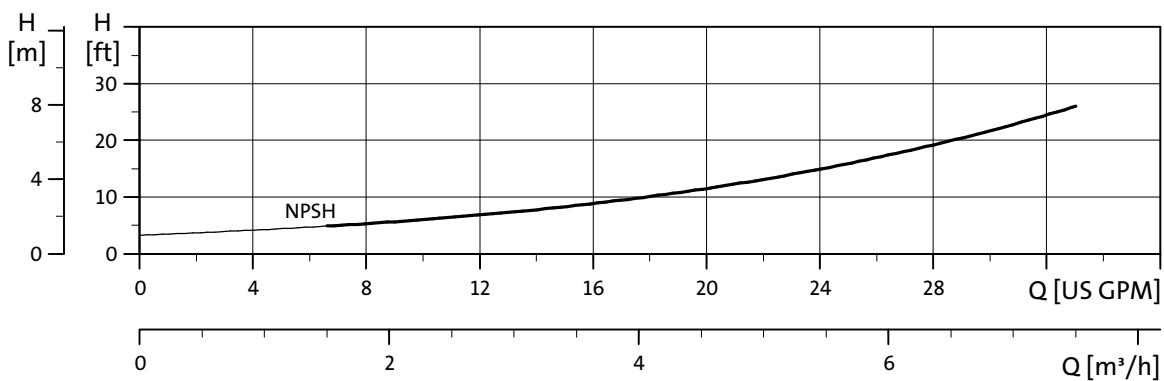
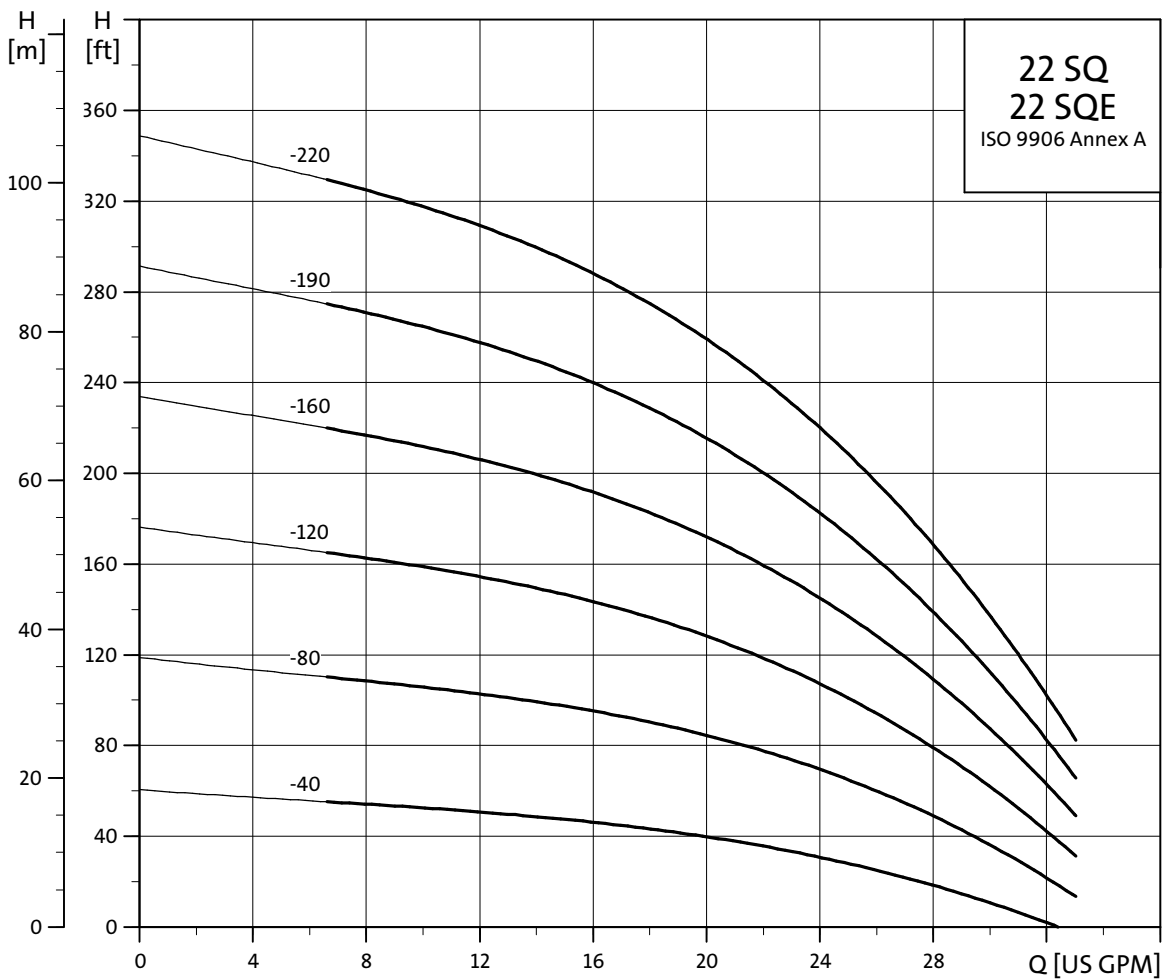

TM04 7466 2010

30 SQ, SQE

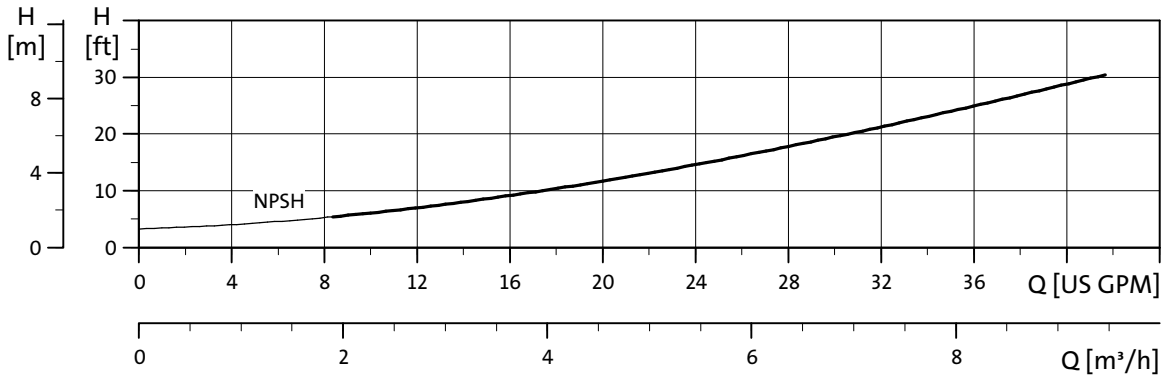
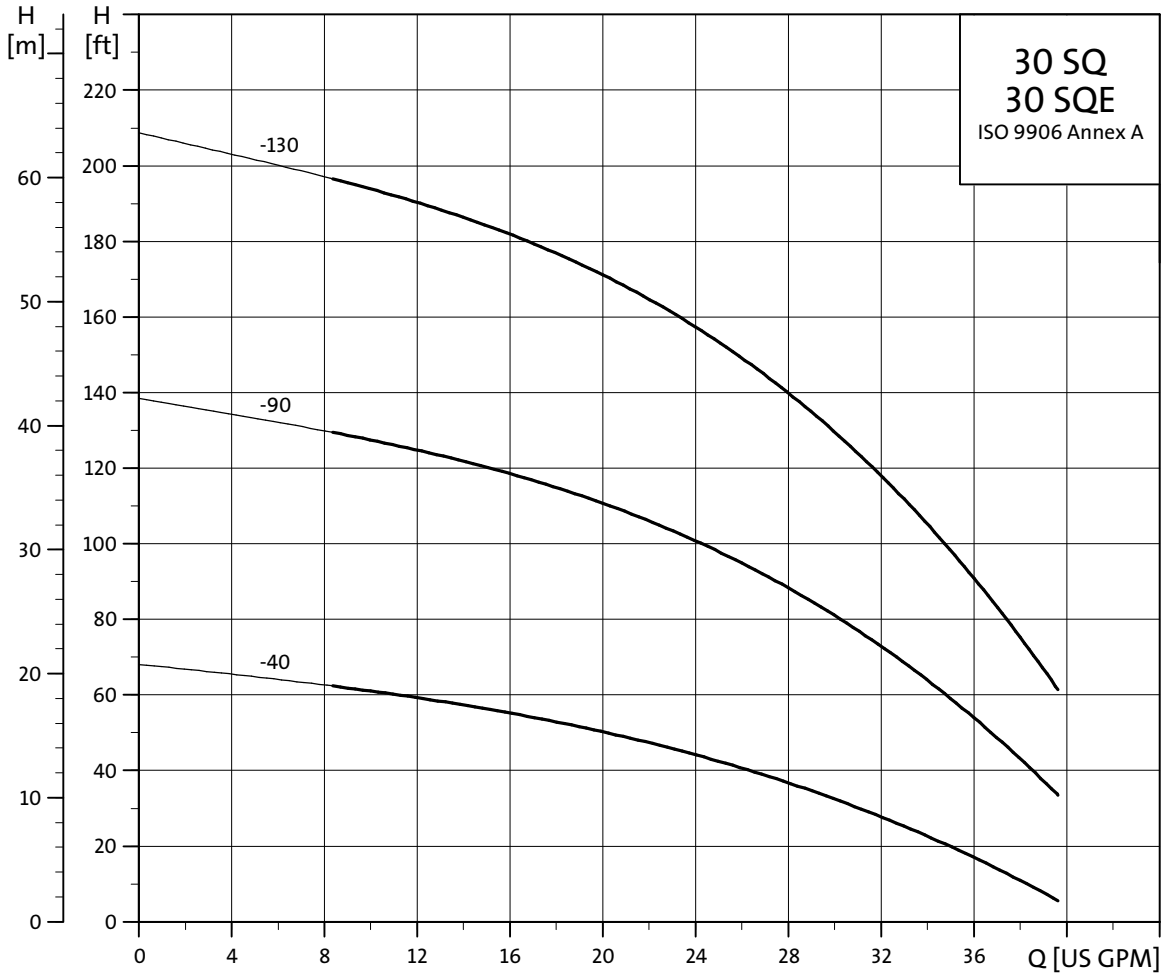

TM04 7467 2010

10 SQE-NE

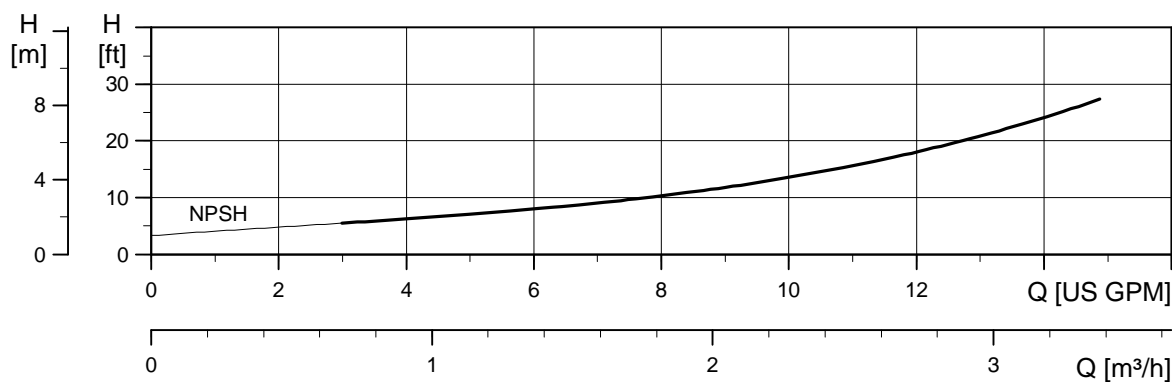
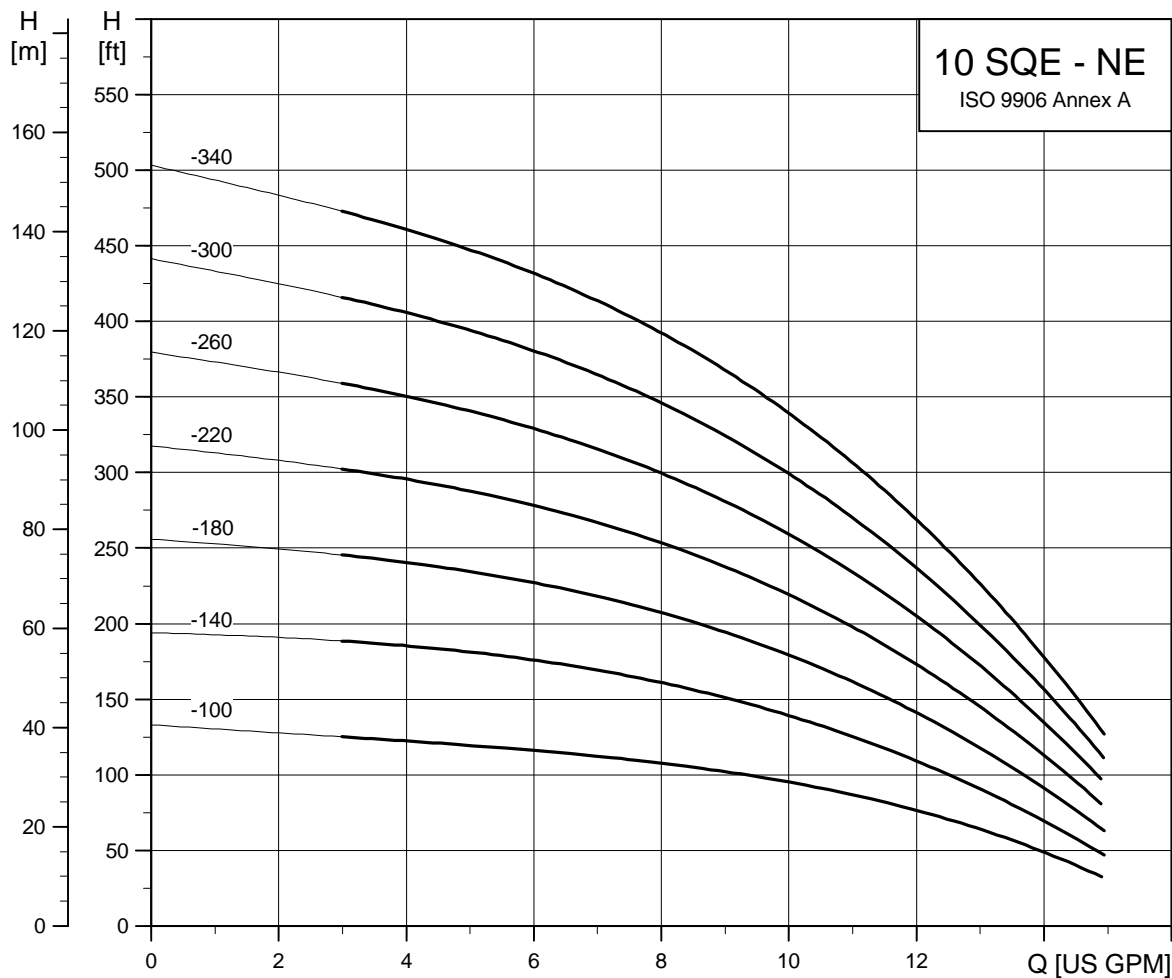

TM04 7468 2010

22 SQE-NE

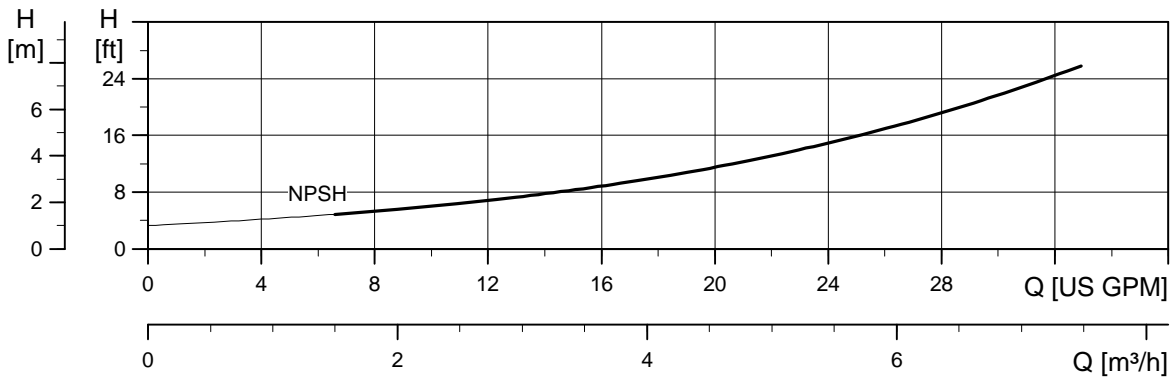
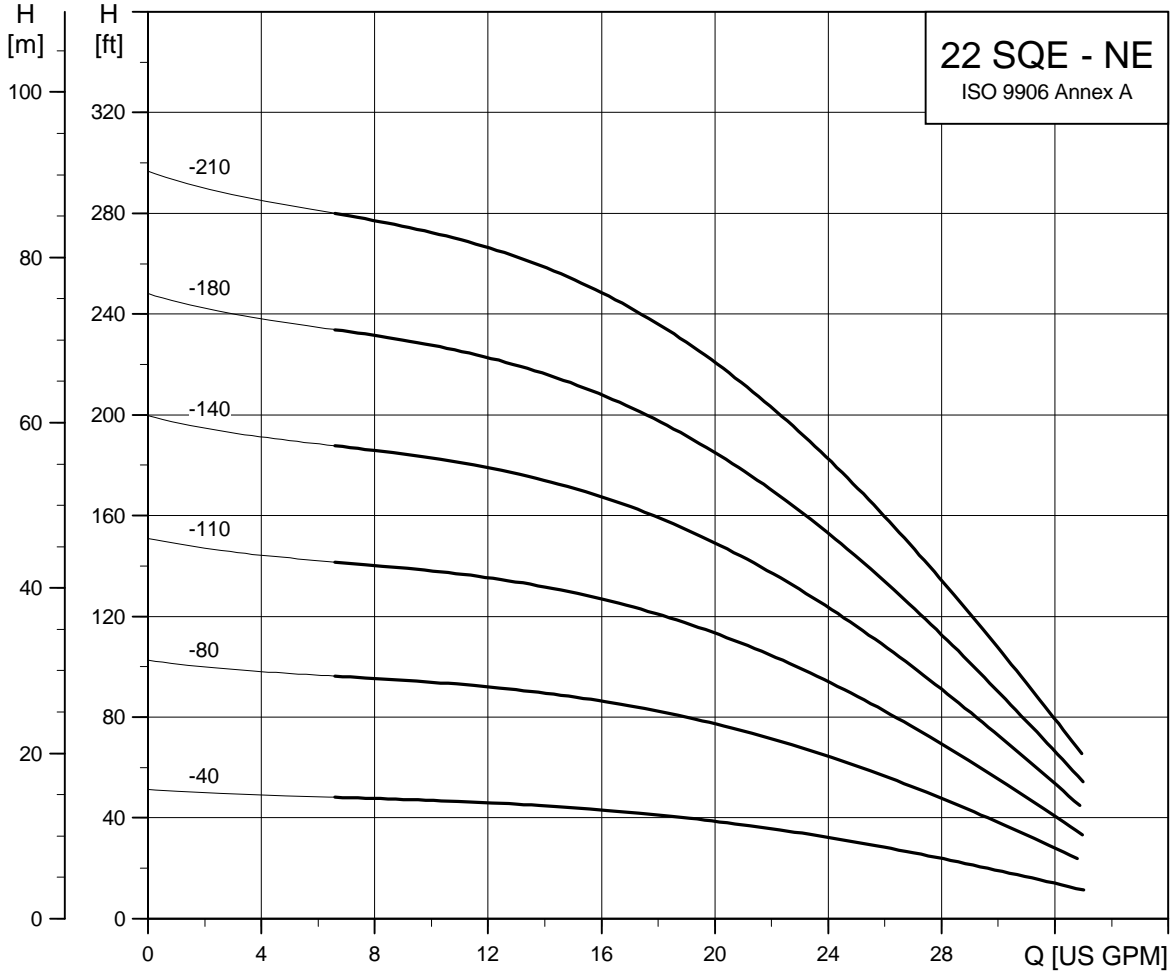

TM04 7469 2010

8. Technical data

Electrical data

Supply voltage:	1x200-240V +6%/-10%, 50/60 Hz, PE 1x100-115V +6%/-10%, 50/60 Hz, PE
Operation via generator:	As a minimum, the generator output must be equal to the motor P1[kw] + 10%
Starting current:	The motor starting current is equal to the highest value stated on the motor nameplate
Starting:	Soft Start
Run-up time:	Maximum: 2 seconds
Motor protection:	Motor is protected against: <ul style="list-style-type: none"> - Dry running - overvoltage - undervoltage - overload - overtemperature.
Power factor:	PF=1
Motor cable:	3 wire, 14AWG XLPE, 5 ft
Motor liquid:	Type SML 2
pH Values:	SQ and SQE: 5 to 9 SQE-NE: 2 to 13
Liquid temperature:	The temperature of the pumped liquid must not exceed 86 °F (30 °C)

Note: If liquids with a viscosity higher than that of water are to be pumped, please contact Grundfos.

Control units CU 300 and CU 301

Voltage:	1 x 100-240 V – 10 %/+ 6 %, 50/60 Hz, PE
Power consumption:	5 W
Current consumption:	Maximum 130 mA
Enclosure class:	IP 55
Ambient temperature:	During operation: –22 °F to +122 °F (–30 °C to +50 °C) During storage: –22 °F to 140 °F (–30 °C to +60 °C)
Relative air humidity:	95 %.
Pump cable:	Maximum length between CU 300 or CU 301 and pump: 650 ft (198 m)
Back-up fuse:	Maximum: 16 A
Radio noise:	CU 300 and CU 301 comply with EMC Directive 89/336/EEC. Approved according to the standards EN 55014 and EN 55014-2
Marking:	CE, cUL (CU 301)
Load:	Max. 100 mA

Operating conditions

Minimum ambient fluid temperature:	+34 °F (+1 °C)
Maximum ambient fluid temperature:	+86 °F (+30 °C)
Well diameter:	3-inch or larger
Installation depth (maximum):	500 feet below static water level

Storage conditions

Minimum ambient temperature:	–4 °F (–20 °C)
Maximum ambient temperature:	+140 °F (+60 °F)
Frost protection:	If the pump has to be stored after use, it must be stored at a frost-free location, or it must be ensured that the motor liquid is frost-proof.

Motor data

Pump type	Hp	Voltage	Full load amps		Overload amps		Min. well diameter	Discharge
			230V	115V	230V	115V		
5SQE05-90	1/2	230V / 115V	2.1	4.2	5	11	3"	1" NPT
5SQE05-140	1/2	230V / 115V	2.9	6.0	5	11	3"	1" NPT
5SQE05-180	1/2	230V / 115V	3.7	7.7	5	11	3"	1" NPT
5SQE07-230	3/4	230V	4.6	-	8	-	3"	1" NPT
5SQE07-270	3/4	230V	5.3	-	8	-	3"	1" NPT
5SQE07-320	3/4	230V	6.2	-	8	-	3"	1" NPT
5SQE10-360	1	230V	7.2	-	11	-	3"	1" NPT
5SQE10-410	1	230V	8.1	-	11	-	3"	1" NPT
5SQE15-450	1 1/2	230V	9.2	-	12	-	3"	1" NPT
10SQE05-110	1/2	230V / 115V	2.9	6.1	5	11	3"	1 1/4" NPT
10SQE05-160	1/2	230V / 115V	4.1	8.6	8	11	3"	1 1/4" NPT
10SQE07-200	3/4	230V	5.3	-	8	-	3"	1 1/4" NPT
10SQE7-240	3/4	230V	6.0	-	8	-	3"	1 1/4" NPT
10SQE10-290	1	230V	7.7	-	11	-	3"	1 1/4" NPT
10SQE15-330	1 1/2	230V	8.9	-	12	-	3"	1 1/4" NPT
15SQE05-70	1/2	230V / 115V	2.9	6.0	5	11	3"	1 1/4" NPT
15SQE05-110	1/2	230V / 115V	4.0	8.3	5	11	3"	1 1/4" NPT
15SQE07-150	3/4	230V	5.1	-	8	-	3"	1 1/4" NPT
15SQE07-180	3/4	230V	6.2	-	8	-	3"	1 1/4" NPT
15SQE10-220	1	230V	7.4	-	11	-	3"	1 1/4" NPT
15SQE10-250	1	230V	8.4	-	11	-	3"	1 1/4" NPT
15SQE15-290	1 1/2	230V	9.7	-	12	-	3"	1 1/4" NPT
22SQE05-40	1/2	230V / 115V	1.9	3.9	5	-	3"	1 1/2" NPT
22SQE05-80	1/2	230V / 115V	3.4	7.2	5	-	3"	1 1/2" NPT
22SQE07-120	3/4	230V	4.9	-	8	-	3"	1 1/2" NPT
22SQE10-160	1	230V	6.4	-	8	-	3"	1 1/2" NPT
22SQE10-190	1	230V	7.9	-	11	-	3"	1 1/2" NPT
22SQE15-220	1 1/2	230V	9.5	-	12	-	3"	1 1/2" NPT
30SQE05-40	1/2	230V / 115V	2.8	5.7	5	-	3"	1 1/2" NPT
30SQE07-90	3/4	230V	5.2	-	8	-	3"	1 1/2" NPT
30SQE10-130	1	230V	7.6	-	11	-	3"	1 1/2" NPT

Dimensions and weights

SQ, SQE

Model	Hp	Motor size	Discharge size	Dimensions in inches					Approx. ship. wt.
				A	B	C	D	E	
5SQ/SQE05-90	1/2	3"	1" NPT	30.4	19.8	10.6	2.6	2.9	12
5SQ/SQE05-140	1/2	3"	1" NPT	30.4	19.8	10.6	2.6	2.9	12
5SQ/SQE05-180	1/2	3"	1" NPT	31.5	19.8	11.6	2.6	2.9	12
5SQ/SQE07-230	3/4	3"	1" NPT	33.6	19.8	13.7	2.6	2.9	13
5SQ/SQE07-270	3/4	3"	1" NPT	33.6	19.8	13.7	2.6	2.9	13
5SQ/SQE07-320	3/4	3"	1" NPT	34.6	19.8	14.8	2.6	2.9	13
5SQ/SQE10-360	1	3"	1" NPT	38.2	21.3	16.9	2.6	2.9	16
5SQ/SQE10-410	1	3"	1" NPT	38.2	21.3	16.9	2.6	2.9	16
5SQ/SQE15-450	1 1/2	3"	1" NPT	39.3	21.3	18.0	2.6	2.9	16
10SQ/SQE05-110	1/2	3"	1 1/4" NPT	30.4	19.8	10.6	2.6	2.9	12
10SQ/SQE05-160	1/2	3"	1 1/4" NPT	30.4	19.8	10.6	2.6	2.9	12
10SQ/SQE07-200	3/4	3"	1 1/4" NPT	31.5	19.8	11.6	2.6	2.9	13
10SQ/SQE07-260	3/4	3"	1 1/4" NPT	33.6	19.8	13.7	2.6	2.9	13
10SQ/SQE10-290	1	3"	1 1/4" NPT	35.0	21.3	13.7	2.6	2.9	16
10SQ/SQE15-330	1 1/2	3"	1 1/4" NPT	36.14	21.3	14.8	2.6	2.9	16
15SQ/SQE05-70	1/2	3"	1 1/4" NPT	30.4	19.8	10.6	2.6	2.9	12
15SQ/SQE05-110	1/2	3"	1 1/4" NPT	30.4	19.8	10.6	2.6	2.9	12
15SQ/SQE07-150	3/4	3"	1 1/4" NPT	31.5	19.8	11.6	2.6	2.9	13
15SQ/SQE07-180	3/4	3"	1 1/4" NPT	33.6	19.8	13.7	2.6	2.9	13
15SQ/SQE10-220	1	3"	1 1/4" NPT	35.0	21.3	13.7	2.6	2.9	16
15SQ/SQE10-250	1	3"	1 1/4" NPT	36.1	21.3	14.8	2.6	2.9	16
15SQ/SQE10-290	1 1/2	3"	1 1/4" NPT	38.2	21.3	16.9	2.6	2.9	16
22SQ/SQE05-40	1/2	3"	1 1/2" NPT	30.4	19.8	10.6	2.6	2.9	12
22SQ/SQE05-80	1/2	3"	1 1/2" NPT	30.4	19.8	10.6	2.6	2.9	12
22SQ/SQE07-120	3/4	3"	1 1/2" NPT	31.5	19.8	11.6	2.6	2.9	13
22SQ/SQE10-160	1	3"	1 1/2" NPT	33.6	19.8	13.7	2.6	2.9	13
22SQ/SQE10-190	1	3"	1 1/2" NPT	38.2	21.3	16.9	2.6	2.9	16
22SQ/SQE15-220	1 1/2	3"	1 1/2" NPT	38.2	21.3	16.9	2.6	2.9	16
30SQ/SQE05-40	1/2	3"	1 1/2" NPT	30.4	19.8	10.6	2.6	2.9	12
30SQ/SQE07-90	3/4	3"	1 1/2" NPT	30.4	19.8	10.6	2.6	2.9	13
30SQ/SQE10-130	1	3"	1 1/2" NPT	35.0	21.3	13.7	2.6	2.9	13

SQE-NE

10SQE-05-100NE	1/2	3"	1 1/4" NPT	30.4	19.8	10.6	2.6	2.9	12
10SQE-05-140NE	1/2	3"	1 1/4" NPT	30.4	19.8	10.6	2.6	2.9	12
10SQE-05-180NE	3/4	3"	1 1/4" NPT	31.5	19.8	11.6	2.6	2.9	13
10SQE-07-220NE	3/4	3"	1 1/4" NPT	33.6	19.8	13.7	2.6	2.9	13
10SQE-10-260NE	1	3"	1 1/4" NPT	35.0	21.3	13.7	2.6	2.9	16
10SQE-10-300NE	1	3"	1 1/4" NPT	36.1	21.3	14.8	2.6	2.9	16
10SQE-10-340NE	1	3"	1 1/4" NPT	38.2	21.3	16.9	2.6	2.9	16
22SQE05-40NE	1/2	3"	1 1/2" NPT	30.4	19.8	10.6	2.6	2.9	12
22SQE05-80NE	1/2	3"	1 1/2" NPT	30.4	19.8	10.6	2.6	2.9	12
22SQE07-110NE	3/4	3"	1 1/2" NPT	31.5	19.8	11.6	2.6	2.9	13
22SQE07-140NE	3/4	3"	1 1/2" NPT	33.6	19.8	13.7	2.6	2.9	13
22SQE10-180NE	1	3"	1 1/2" NPT	38.2	21.3	16.9	2.6	2.9	16
22SQE10-210NE	1	3"	1 1/2" NPT	38.2	21.3	16.9	2.6	2.9	16

9. Construction

Materials of construction

SQ, SQE	
Component	Splined shaft
Valve casing	Polyamide
Discharge chamber	304 stainless steel
Valve guide	Polyamide
Valve spring	316LN stainless steel
Valve cone	Polyamide
Valve seat	NBR rubber
O-ring	NBR rubber
Lock ring	310 stainless steel
Top bearing	NBR rubber
Top chamber	Polyamide
Guide vanes	Polyamide
Impeller	Polyamide w/ tungsten carbide bearings
Bottom chamber	Polyamide
Neck ring	TPU / PBT
Bearing	Aluminum oxide
Suction interconnector	Polyamide
Ring	304 stainless steel
Pump sleeve	304 stainless steel
Pressure equalization cone	Polyamide
Spacer	Polyamide
Sand trap	316 stainless steel
Shaft w/coupling	304 stainless steel
Cable guard	304 stainless steel

SQE-NE	
Component	Splined shaft
Valve casing	PVDF
Discharge chamber	316 stainless steel
O-ring	FPM rubber
Valve cone	PVDF
Valve seat	FPM rubber
Top chamber	PVDF
Empty chamber	PVDF
Top bearing	FPM rubber
Neck ring	PVDF
Lock ring	316 stainless steel
Guide vanes	PVDF
Bottom chamber	PVDF
Impeller w/ tungsten carbide bearing	PVDF
Suction interconnector	PVDF
Ring	316 stainless steel
Shaft w/coupling	Sintered steel 316 stainless steel
Cable guard	316 stainless steel
Cable guard screws	316 stainless steel
Pressure equalization cone	PVDF
Valve spring	316 stainless steel
Pump sleeve	316 stainless steel
Valve guide	PVDF
Spacer	316 stainless steel

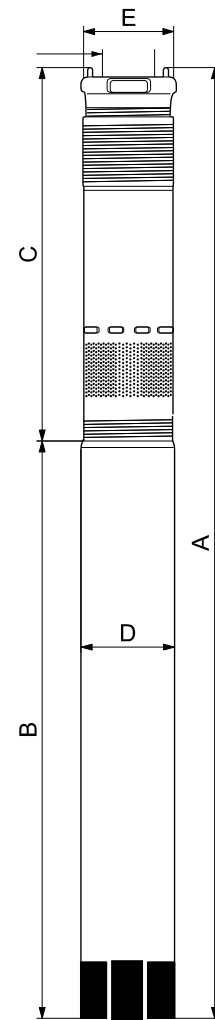

Discharge sizes:
 1" NPT 5 SQ/SQE
 1 1/4" NPT 10 - 15 SQ/SQE
 1 1/2" NPT 22-30 SQ/SQE

TM04 7522 2110

Material specification

Pump						
Pos.	Component	Material	DIN W-Nr. SQ/SQE	AISI	DIN W-Nr. SQE-NE	AISI
1	Valve casing	Polyamide	1.4301	304	1.4401	316
1a	Discharge chamber	Stainless steel				
1d	O-ring	NBR rubber				
2	Valve cup	Polyamide				
3	Valve seat	NBR rubber				
4a	Empty chamber	Polyamide				
6	Top bearing	NBR rubber				
7	Neck ring	TPU / PBT				
7a	Lock ring	Stainless spring steel	1.4301	310	1.4401	316
7b	Neck ring retainer	Polyamide				
9b	Chamber top	Polyamide				
9c	Chamber bottom	Polyamide				
13	Impeller with tungsten carbide bearing	Polyamide				
14	Suction inter-connector	Polyamide				
14a	Ring	Stainless steel	1.4301	304	1.4401	316
16	Shaft with coupling	Stainless steel Sintered steel	1.4301	304	1.4401	316
18	Cable guard	Stainless steel	1.4301	304	1.4401	316
18a 18b	Screws for cable guard	Stainless steel	1.4301	316	1.4401	316
30	Cone for pressure equalization	Polyamide				
32	Guide vanes	Polyamide				
39	Spring	Stainless spring steel	1.4406	316LN	1.4406	316LN
55	Pump sleeve	Stainless steel	1.4301	304	1.4401	316
64	Priming screw	Polyamide				
70	Valve guide	Polyamide				
86	Lip seal ring	NBR rubber				
87	Cone for pressure equalization complete	Polyamide / NBR rubber				

Motor						
Pos.	Component	Material	DIN W-Nr. SQ-SQE	AISI	DIN W-Nr. SQE-NE	AISI
201	Stator	Stainless steel	1.4301	304	1.4401	316
202	Rotor	Stainless steel	1.4301	304	1.4401	316
202a	Stop ring	PP				
202b	Filter	Polyester				
203	Thrust bearing	Carbon				
205	Radial bearing	Ceramic tungsten carbide				
220	Motor cable with plug	EPR				
222a	Filling plug	MS 3: NBR MSE 3: FKM				
224	O-ring	FKM				
225	Top cover	PPS				
232	Shaft seal	MS 3: NBR MSE 3: FKM				
	Motor liquid	SML-2				

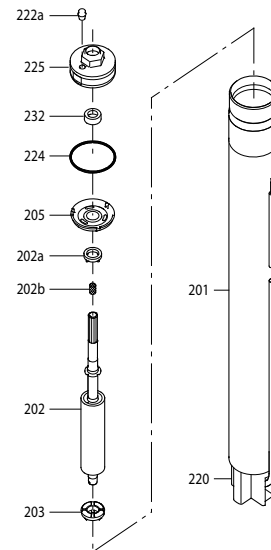
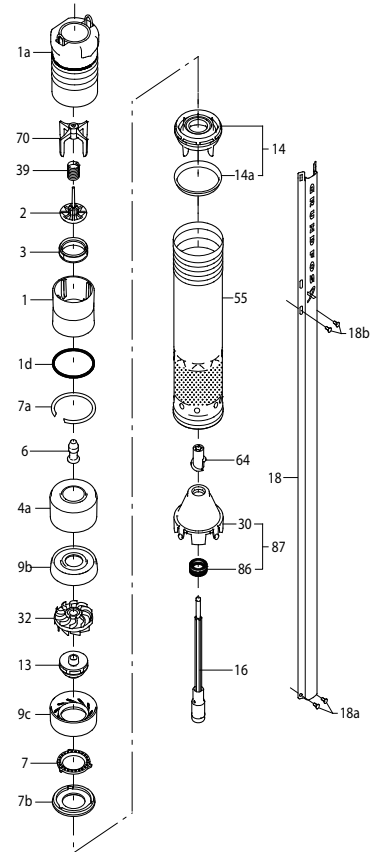

TM01 2745 2010

10. Control units

CU 301

The CU 301 is a control and communication unit developed especially for the SQE submersible pumps in constant-pressure applications.

The CU 301 control unit provides:

- Full control of the SQE pumps
- two-way communication with the SQE pumps
- possibility of adjusting the pressure
- alarm indication (LED) when service is needed
- possibility of starting, stopping and resetting the pump simply by means of a push-button
- configuration with R100 remote control.

The CU 301 communicates with the pump via mains borne signalling (Power Line Communication), meaning that no extra cables are required between the CU 301 and the pump.

The CU 301 features the following indications (see drawing in right column):

1. Pump running indicator
2. System pressure setting
3. System ON/OFF
4. Button lock indicator
5. Dry-running indicator
6. Service needed in case of:
 - no contact to pump
 - overvoltage
 - undervoltage
 - speed reduction
 - overtemperature
 - overload
 - sensor defective.

The CU 301 incorporates:

- External signal input for pressure sensor
- connection to an operating relay for indication of pump operation.

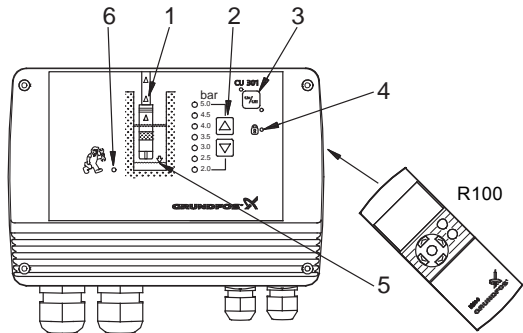

Fig. 15 CU 301 control unit

TM03 3426 0406

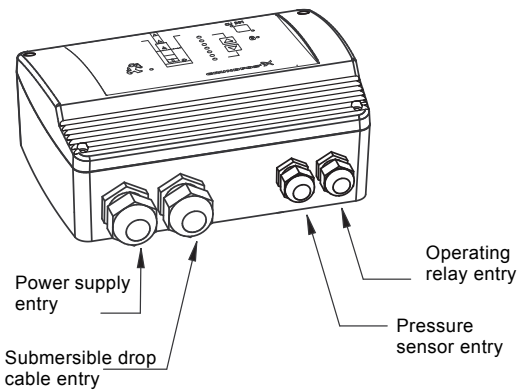

Fig. 16 CU 301 entry ports

TM02 3427 0406

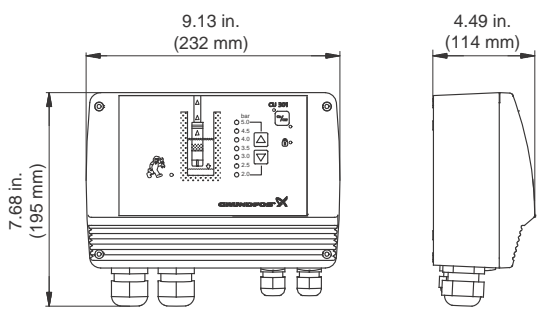

Fig. 17 CU 301 dimensions

TM03 3003 2010

Optional R100 remote control

Wireless infrared remote control of the CU 301 is possible by means of the R100.

Using the R100, it is possible to monitor and change the operating parameters, see the R100 menu structure on page 31.

The R100 is a valuable tool in case fault finding is required.

R100 menu structure for CU 301 control unit

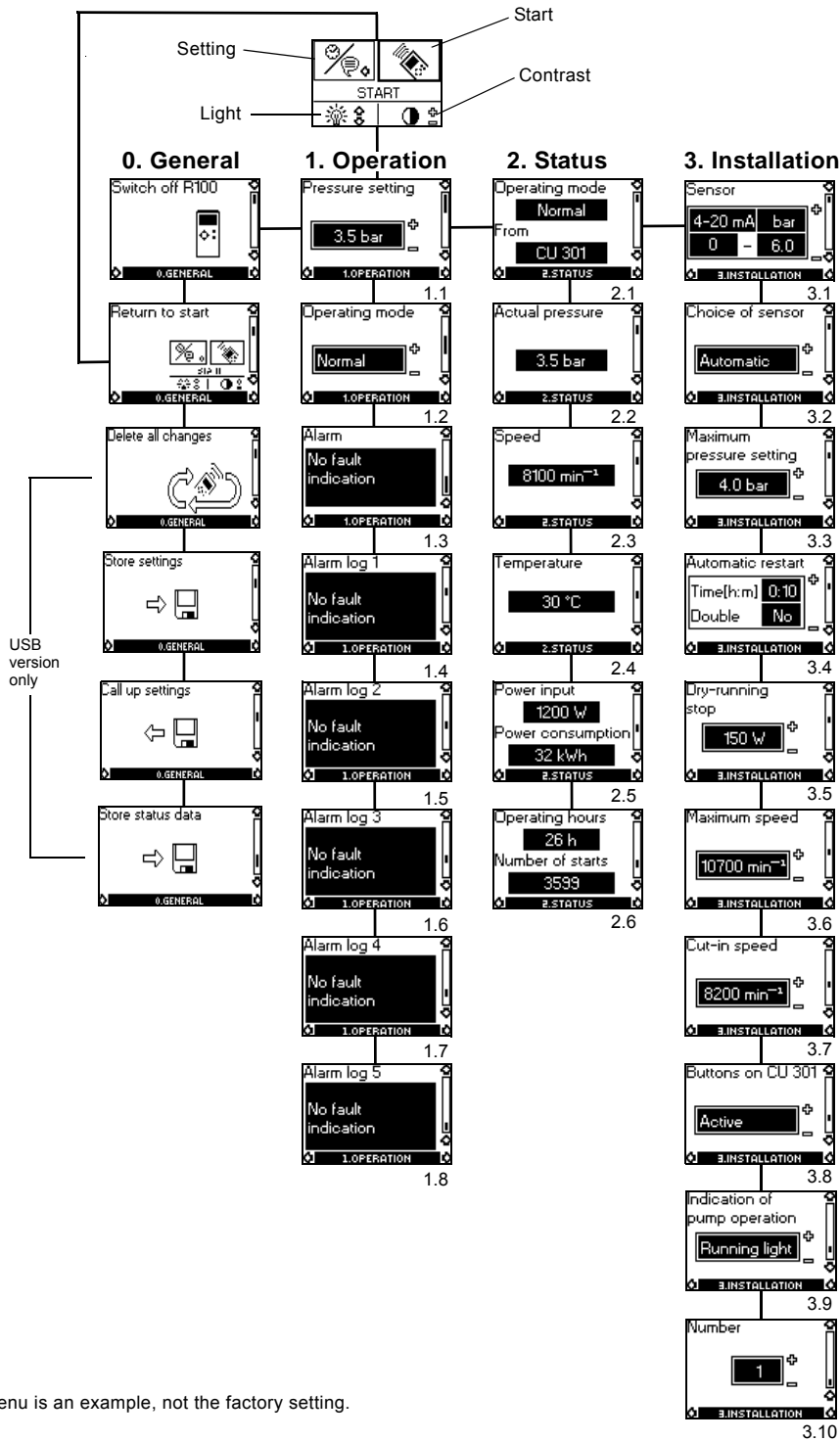

Note: This menu is an example, not the factory setting.

R100 menus for CU 301

0. General

1. Operation

- 1.1 Setpoint setting
- 1.2 Selection of operating mode
- 1.3 Alarm indication.

2. Status

The indication of:

- 2.1 Actual operating mode
- 2.2 Actual pressure
- 2.3 Actual motor speed
- 2.4 Actual motor temperature
- 2.5 Actual power input and accumulated motor power consumption
- 2.6 Accumulated number of operating hours and accumulated number of starts.

3. Installation

- 3.1 Sensor parameters
- 3.2 Choice of sensor
- 3.3 Setting of maximum pressure setpoint
- 3.4 Setting of automatic restart time
- 3.5 Setting of the dry-running stop limit
- 3.6 Setting of the maximum motor speed
- 3.7 Setting of the cut-in motor speed
- 3.8 Activating or deactivating the on/off-button and the buttons for system pressure setting on the CU 301
- 3.9 Indication of pump operation
- 3.10 Allocation of identification number.

CU 300

The CU 300 is a control and communication unit developed especially for the SQE submersible pumps for control applications other than constant pressure.

The CU 300 control unit provides:

- Flexible pump control based on various sensor inputs
- two-way communication with the SQE pumps
- alarm indication of pump operation by LED's on the front
- possibility of starting, stopping and resetting the pump simply by means of a push-button
- communication with R100 remote control.

The CU 300 communicates with the pump via mains borne signalling (Power Line Communication), meaning that no extra cables are required between the CU 300 and the pump.

The following alarms can be indicated by the CU 300:

- No contact
- overvoltage
- undervoltage
- dry running
- speed reduction
- overtemperature
- overload
- sensor alarm.

The CU 300 incorporates:

- External signal input for two analog sensors and one digital sensor
- relay output for external alarm indication
- control according to the signals received, e.g. of flow, pressure, water level and conductivity.

R100 remote control

Wireless infrared remote control of the CU 300 is possible by means of the R100.

Using the R100, it is possible to monitor and change the operating parameters, see the R100 menu structure on page 34.

The R100 is a valuable tool in case fault finding is required.

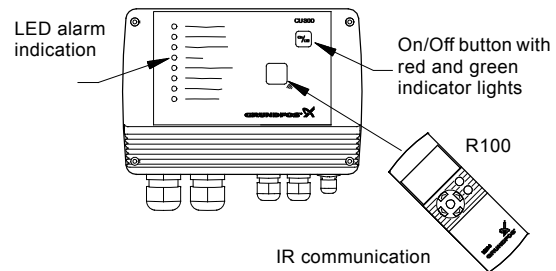

Fig. 18 CU 300 control unit with R100

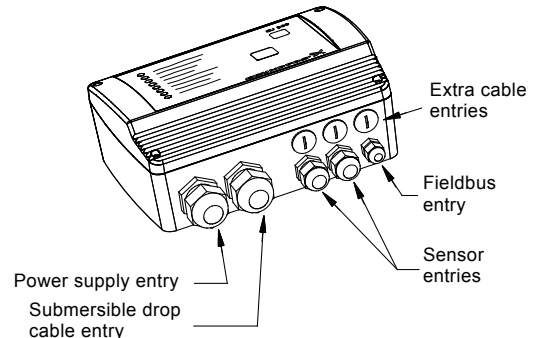

Fig. 19 CU 300 control unit, external entry ports

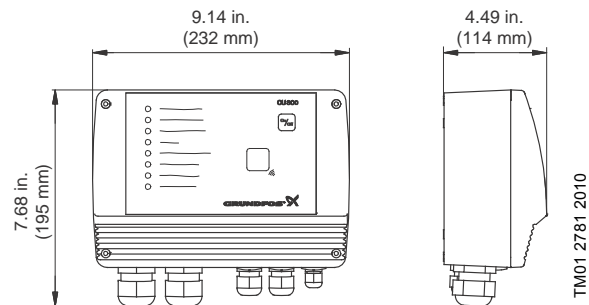
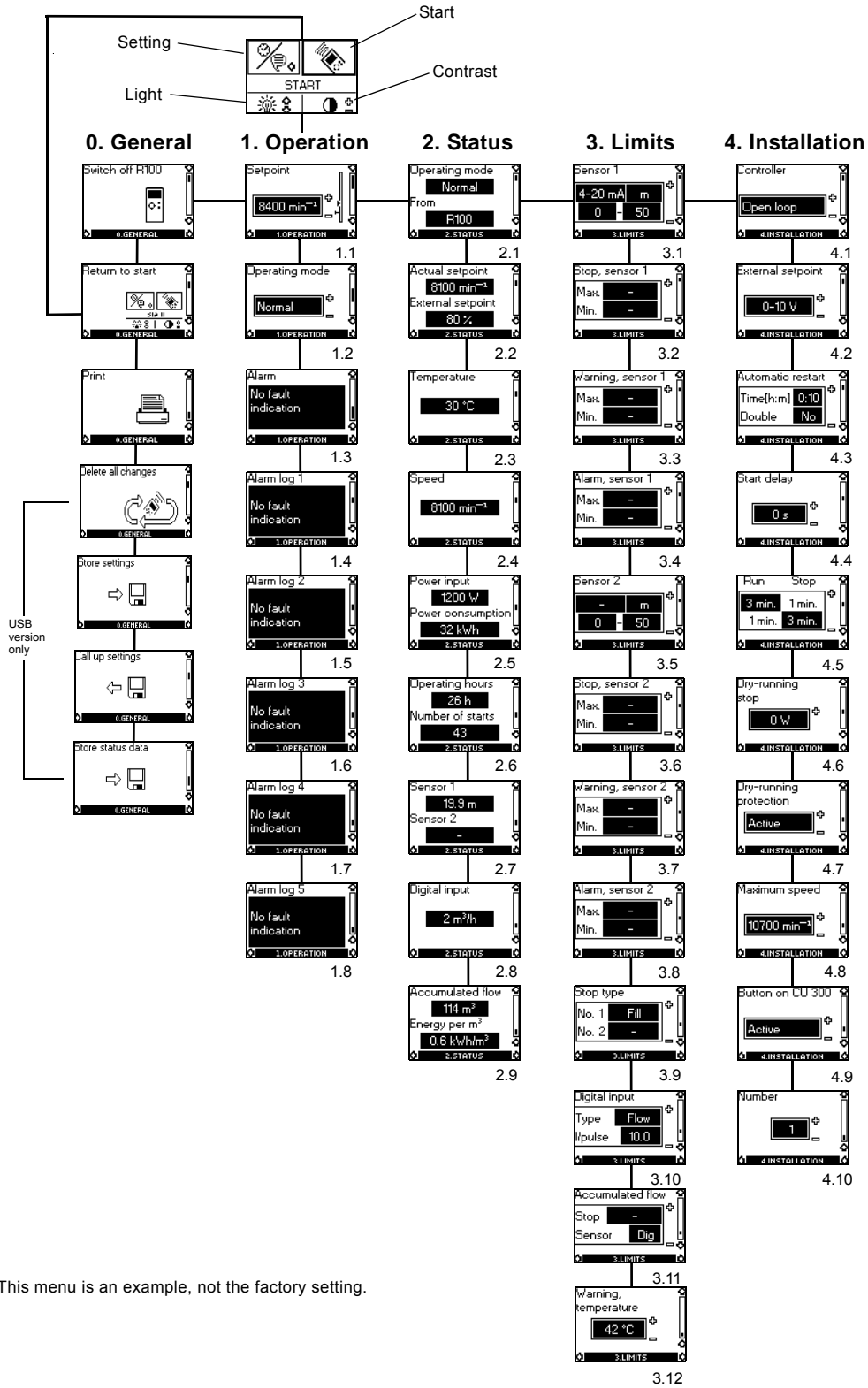

Fig. 20 CU 300 dimensions

R100 menu structure for the CU 300



Note: This menu is an example, not the factory setting.

R100 menus for CU 300

0. General

1. Operation

- 1.1 Setpoint setting
- 1.2 Selection of operating mode
- 1.3 Alarm indication.

2. Status

The indication of:

- 2.1 Actual operating mode
- 2.2 Actual and external setpoint
- 2.3 Actual motor temperature
- 2.4 Actual motor speed
- 2.5 Actual power input and accumulated motor power consumption
- 2.6 Accumulated number of operating hours and accumulated number of starts
- 2.7 Actual values of sensors 1 and 2, respectively
- 2.8 Actual values of the digital input
- 2.9 Accumulated flow, and the power used to pump.

R100 offers the possibility of making a number of settings.

3. Limits

The setting of:

- 3.1 Sensor 1 parameters
- 3.2 Min. and max. stop limits of sensor 1
- 3.3 Min. and max. warning limits of sensor 1
- 3.4 Min. and max. alarm limits of sensor 1
- 3.5 Sensor 2 parameters
- 3.6 Min. and max. stop limits of sensor 2
- 3.7 Min. and max. warning limits of sensor 2
- 3.8 Min. and max. alarm limits of sensor 2
- 3.9 Filling or emptying
- 3.10 Setting of the function of the digital sensor connected to the digital input
- 3.11 The setting of the water quantity stop limit and the setting of the sensor to detect water quantity
- 3.12 The setting of the temperature warning limits of the motor electronics.

4. Installation

- 4.1 Selection of controller — open loop, closed loop
- 4.2 Setting of external setpoint
- 4.3 Setting of automatic restart time
- 4.4 Allocation of individual start delays
- 4.5 Setting of the stop and run times for the dewatering function
- 4.6 Setting of the dry-running stop limit
- 4.7 Activating or deactivating the dry-running protection
- 4.8 Setting of the maximum motor speed
- 4.9 Activating or deactivating the on/off-button on the CU 300
- 4.10 Allocation of ID number where more than one CU 300 is installed.

Examples of R100 displays

Menu OPERATION

Setpoint setting

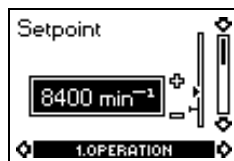

1.1

From factory, the pump is set to maximum speed, 10,700 rpm. R100 makes it possible to reduce the pump speed by changing the setpoint. The speed can be set to 3,000 - 10,700 rpm, at 100 rpm intervals.

The unit of the setpoint is automatically changed according to the unit of the sensor connected to sensor input 1.

Example: Sensor input 1 is connected to a pressure sensor using the unit feet (ft) and the range 0-60. Consequently, the setpoint of display 1.1 can be set to between 0-60 ft.

Menu STATUS

The displays appearing in this menu are status displays only. It is not possible to change settings in this menu.

Accumulated flow

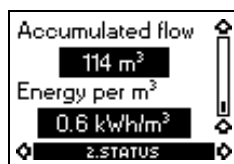

2.9

In display 2.9, the water quantity (m³)* pumped is shown. The value shown is the accumulated flow registered by the sensor selected in display 3.11.

The power used to pump 1 m³ is shown in the display as energy per m³ (kWh/m³).

It is possible to read the status of the accumulated flow and energy per m³ at any time.

*Water quantity in units of gpm can be chosen.

Accumulated number of operating hours and number of starts



2.6

The number of operating hours and the number of starts are values accumulated from the time of installation and they cannot be reset.

Both values are stored in the motor electronics, and they are kept even if the CU 300 is replaced.

The number of operating hours is registered every two hours of continuous operation.

Menu LIMITS

Sensor 1

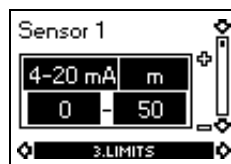

3.1

The setting of sensor 1.

Depending on the type of sensor, the following settings can be made:

- Sensor outputs:
 - (not active), 0-10 V, 2-10 V, 0-20 mA, 4-20 mA
- setting range unit: m³/h, m, %, gpm, ft
- sensor minimum value: 0-249 (0, 1, 2, 3.....249)
- sensor maximum value: 1-250 (1, 2, 3, 4.....250).

11. CU331SP variable frequency drive

Features

User interface

The user interface offers these possibilities:

- Local operation via a control panel with graphic display where the menu structure is based on the well-known system from Grundfos E-pumps.
- Monitoring of operating status via indicator lights and signal relays.
- Display of alarm or warning and logging of the last five alarms and warnings.

Functions

Control mode: Constant pressure

The CU331SP has only one control mode, Constant pressure. The pressure is kept constant, independently of the flow rate.

Start-up guide

The CU331SP has a start-up guide, which is launched at the first power up. Parameters are set manually on the basis of the installation. The start-up guide can be repeated, if necessary.

Thanks to the start-up guide, the installer can quickly set a few parameters and put the CU331SP into operation.

Direction of rotation test

During start-up, the CU331SP automatically tests and sets the correct direction of rotation without changing the cable connections. The direction of rotation test can be performed manually if it fails for any reason.

Dry-running protection

To protect the pump, the CU331SP will automatically set up dry-run protection so that water shortage can be detected. The dry-run alarm will automatically reset 30 minutes after the alarm is declared.

Low-flow stop function

The low-flow stop function is used for changing between on/off operation at low flow rate and continuous operation at high flow rate.

The low-flow stop function protects the pump and saves energy.

Applications

For 4" or larger wells. Main applications:

- Domestic and light commercial water supply
- irrigation
- livestock watering
- water transfer.

System components

- Compact, efficient, and reliable variable frequency drive
- rugged stainless steel pump end and proven, reliable, 3-phase motor
- pressure sensor
- diaphragm tank (sold separately).



Fig. 21 CU331SP variable frequency drive and sensor

TM05 5601 4012

Identification

Nameplate

The CU331SP can be identified by means of the nameplate. An example is shown below.



Fig. 22 Example of nameplate

Key	
Text	Description
T/C:	CU-331 (product name)
Prod.no:	Product number (98370280)
S/N:	Serial number (000201H462) The last four digits indicate the production date. In this case, 46 is the week, and 2 is the year 2012.
3.0 hp	Typical shaft power on the motor
IN:	Supply voltage, frequency and maximum input current.
OUT:	Motor voltage, frequency and maximum output current. The maximum output frequency usually depends on the pump type.
Type 12 / IP55	Enclosure class
Tamb.	Maximum ambient temperature

CU331SP product range

Enclosure type	NEMA	Hp	Input Ph	Input volts
Indoor	Type 12	2	1	200 - 240
		3	1	200 - 240
		5	1	200 - 240
Outdoor	Type 4X	2	1	200 - 240
		3	1	200 - 240
		5	1	200 - 240

CU331SP performance range

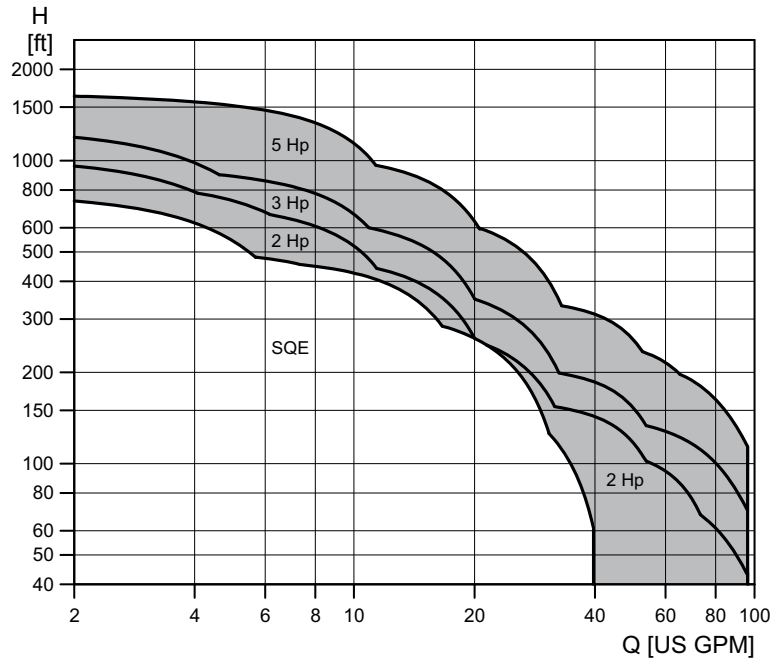

TM05 6380 5012

CU331SP sizing

Step 1

Calculate maximum head requirements at rated flow conditions:

$H_{max} = \text{dynamic head} + \text{system psi (in feet)} + \text{friction loss} + \text{above grade elevation.}$

Step 2

Select pump from performance curves as follows:

Select a model in which the calculated value of H_{max} is within the maximum performance curve of the pump. Refer to section [CU331SP curve charts](#) on page 53.

Step 3

Select the CU331SP that corresponds to the correct motor Hp and enclosure type.

CU331SP operation

Menu structure

The CU331SP has a start-up guide, which is launched at the first power up. After the start-up guide, the CU331SP has a menu structure divided into four main menus:

0. **GENERAL** gives access to the start-up guide for the general setting of the CU331SP.
1. **OPERATION** enables the setting of setpoint and resetting of alarms. It is also possible to see the latest five warnings and alarms.
2. **STATUS** shows the status of the CU331SP and the pump. It is not possible to change or set values.
3. **INSTALLATION** gives access to available parameters.

CU331SP menu overview

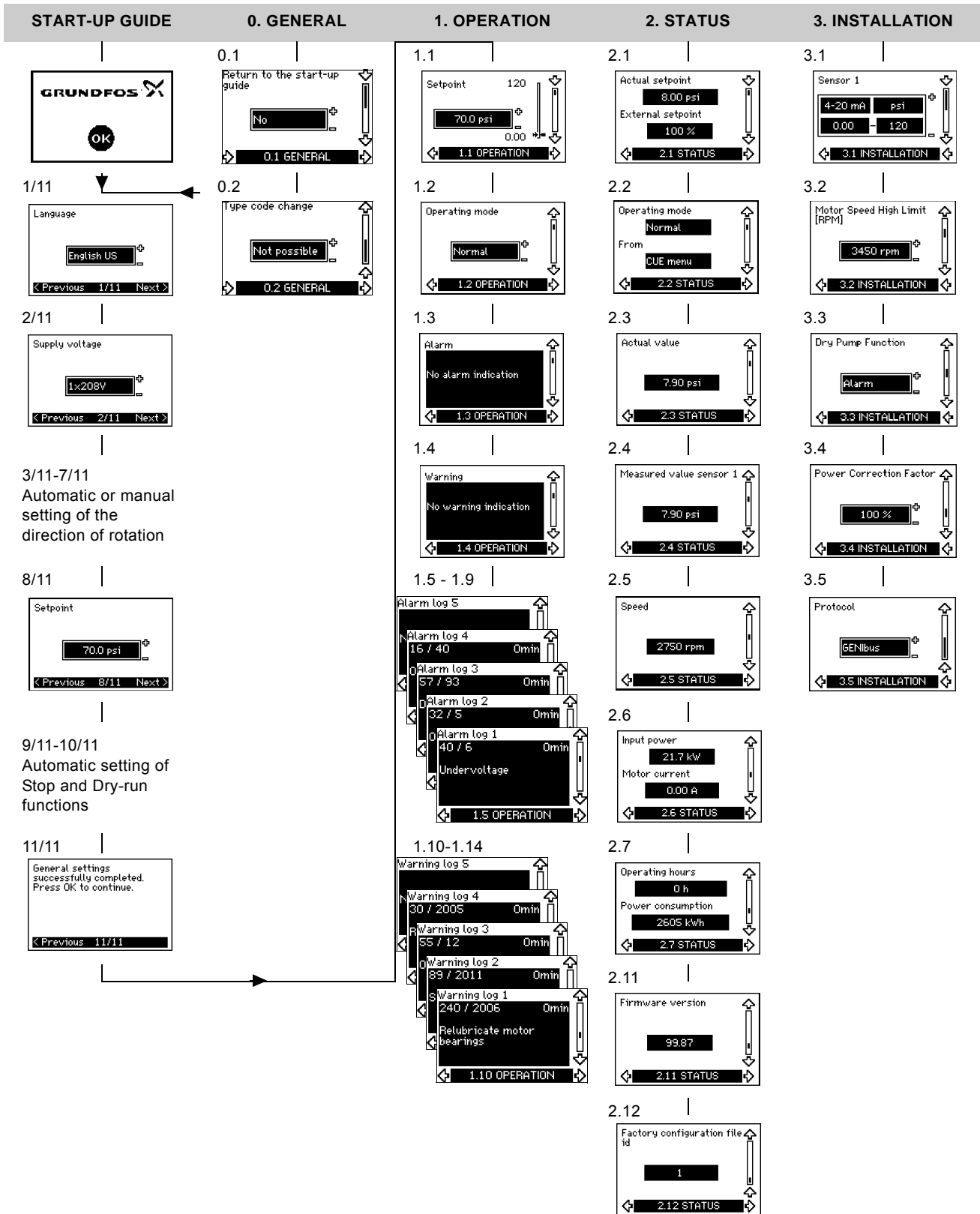

Fig. 23 Menu overview

Operating modes

These operating modes can be selected with the CU331SP:

- Normal
- Stop
- Min.
- Max.

The operating modes can be set without changing the setpoint setting.

Normal

The pump operates in constant pressure mode.

Stop

The pump has been stopped by user.

Min. curve

The pump is running at a set minimum speed value. See fig. 24.

For instance, this operating mode can be used during periods with a very small flow requirement.

Max. curve

The pump is running at a set maximum speed value.

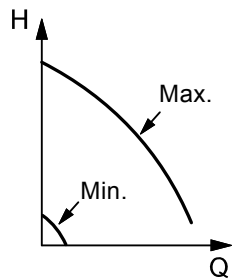

Fig. 24 Min. and max. curves

Control mode

The CU331SP has been developed specifically to operate submersible pumps in Constant Pressure mode. This Closed-Loop control mode uses an analog pressure transducer to provide pressure feedback to the drive.

Constant pressure with stop function

The outlet pressure is kept constant at high flow rate ($Q > Q_{min}$). On/off operation at low flow rate. See fig. 25.

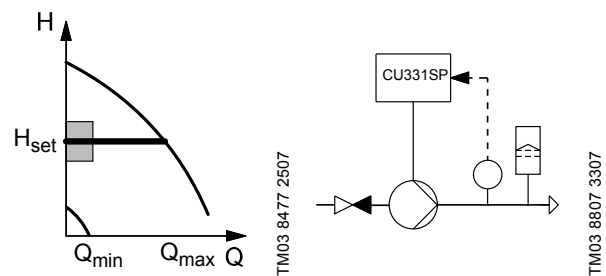

Fig. 25 Constant pressure with stop function

The pump is controlled according to a constant pressure measured after the pump. This means that the pump offers a constant pressure in the Q -range of Q_{min} to Q_{max} , represented by the horizontal line in the QH diagram.

Setting the setpoint by means of the OPERATION menu

The setpoint can be set or changed during operation using the setpoint display in the "OPERATION" menu shown below. It is not necessary to run the start guide to change the setpoint.

Low flow and stop functions

The pump will check the flow regularly by reducing the speed for a short time. If there is no or only a small change in pressure, this means that there is low flow.

The speed will be increased until the stop pressure (actual setpoint + $0.5 \times \Delta H$) is reached and the pump will stop after a few moments. The pump will restart at the latest when the pressure has fallen to the start pressure (actual setpoint - $0.5 \times \Delta H$).

TM03 8813 2507

TM03 8477 2507

TM03 8807 3307

Operating conditions for the stop function

It is only possible to use the stop function if the system incorporates a pressure sensor, a non-return valve and a diaphragm tank.

The non-return valve must always be installed before the pressure sensor.

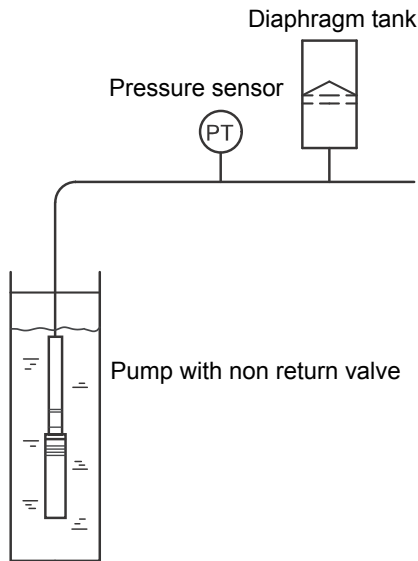

Fig. 26 Position of the pressure sensor and diaphragm tank

TM05 5804 4012

Diaphragm tank

The stop function requires a diaphragm tank of a certain minimum size. The tank must be installed as close as possible after the pump and the precharge pressure must be 0.7 x actual setpoint.

Recommended diaphragm tank size:

Rated flow of pump [gpm (m ³ /h)]	Typical diaphragm tank size [gal (l)]
0-26 (0-6)	2 (7.5)
27-105 (7-24)	4 (15.1)

If a diaphragm tank of the above size is installed in the system, the factory setting of ΔH is the correct setting. If the tank installed is too small, the pump will start and stop too often.

Setting the direction of rotation

The start-up guide is started the first time the CU331SP is connected to supply voltage. Then while going through the start-up guide, the CU331SP tests and sets the correct direction of rotation without changing the cable connections to the motor.

The correct direction of rotation can be set in these ways:

- automatic setting.
- manual setting when the direction of rotation is not visible.

Automatic setting

The CU331SP automatically tests and sets the correct direction of rotation without changing the cable connections.

Automatic setting requires a sensor.

This test is not suitable for all pump types and will in certain cases not be able to determine for certainty the correct direction of rotation. In these cases, the CU331SP changes over to manual setting where the direction of rotation is determined on the basis of the installer's observations.

Manual setting when the direction of rotation is not visible

The correct direction of rotation is set manually without changing the cable connections. This requires that it is possible to observe the head or flow rate.

Status functions

The CU331SP shows the following data:

- power consumption
- operating hours
- measured value
- speed
- input power
- motor current.

The status information can be shown in the display.

Power consumption

The value of the power consumption is an accumulated value calculated from the pump's startup date and cannot be reset. No additional sensor is required.

Operating hours

The value of operating hours is an accumulated value calculated from the pump's startup date and cannot be reset. No additional sensor is required.

Measured value

Sensor display will show the actual pressure as received from the pressure transducer.

Speed

Display will show the motor speed in RPM's (calculated).

Input power

Display will show the power consumption in kW.

Motor current

Display will show the actual motor current being used.

Logging functions

Alarm and warning log

The latest five alarms and five warnings are logged with a timestamp corresponding to the power-on time after the fault has occurred. The alarm and warning log can be shown directly on the display.

See section [Warning and alarm list](#).

Signal relays

The table shows the function of the signal relays.

Type	Function
Relay 1	• Pump running
Relay 2	• Alarm

See also fig. 27.

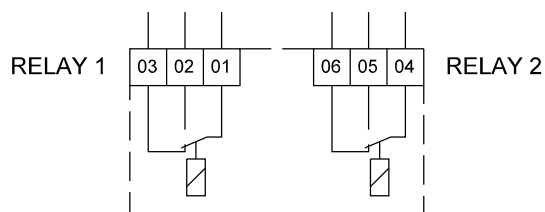

TM03 8801 3407

Fig. 27 Terminals for signal relays (normal state, not activated)

Terminal	Function
C1 C2	Common
NO 1 NO 2	Normally open contact
NC1 NC2	Normally closed contact

CU331SP installation

Mechanical installation

The individual CU331SP cabinet sizes are characterized by their enclosures. The table in section [CU331SP technical data](#) shows the relationship of enclosure class and enclosure type.

Reception and storage

Check on receipt that the packaging is intact, and the unit is complete. In case of damage during transport, contact the transport company to file a claim.

Note that the CU331SP is delivered in a packaging which is not suitable for outdoor storage.

Transportation and unpacking

The CU331SP must only be unpacked at the installation site to prevent damage during the transport to the site.

The packaging contains accessory bag(s), documentation and the unit itself. See fig. 28.



TM05 5990 4012

Fig. 28 CU331SP packaging

Space requirements and air circulation

CU331SP units can be mounted side by side, but as a sufficient air circulation is required for cooling these requirements must be met:

- Sufficient free space above and below the CU331SP
- Ambient temperature up to 122°F (50 °C)
- Hang the CU331SP directly on the wall, or fit it with a back plate. See fig. 29.

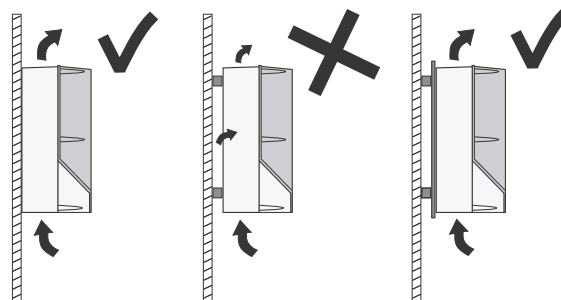

TM03 8859 2607

Fig. 29 CU331SP hung directly on the wall or fitted with a back plate

Required free space above and below the CU331SP:

Enclosure	Space [in (mm)]
B1	7.9 (200)

For information about enclosure, see section [Enclosure](#).

Mounting

The CU331SP must be mounted securely on a firm surface. Ensure that screws are sized appropriately for the weight of the CU331SP (approximately 60 lbs) and anchored securely to the mounting surface.

1. Mark and drill holes. See fig. 30; also see section [Main dimensions and weight](#).
2. Fit the screws, but leave loose. Mount the CU331SP, and tighten the four screws.

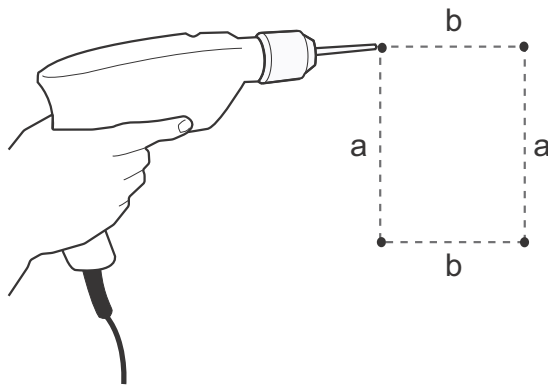

Fig. 30 Drilling holes for mounting

TM03 8860 2607

CU331SP electrical connection

Ensure the correct grounding and protection procedures are used for the installation. Before the electrical installation, ensure that the power supply and other voltage inputs are switched off.

Electrical protection

Protection against electric shock, indirect contact

The leakage current to ground exceeds 3.5 mA, and a reinforced ground connection is required.

Protective conductors must always have a yellow/green (PE) or yellow/green/blue (PEN) color marking. Instructions according to EN IEC 61800-5-1:

- The CU331SP must be stationary, installed permanently and connected permanently to the mains supply.
- The ground connection must be carried out with duplicate protective conductors or with a single reinforced protective conductor with a cross-section of minimum AWG 7 (10 mm²).

Protection against short-circuit, fuses

The CU331SP and the supply system must be protected against short-circuit.

Grundfos requires that the back-up fuses are used for protection against short-circuit.

The CU331SP offers complete short-circuit protection in case of a short-circuit on the motor output.

Additional protection

The leakage current to ground exceeds 3.5 mA.

If the CU331SP is connected to an electrical installation where an earth leakage circuit breaker (ELCB) is used as additional protection, the circuit breaker must be of a type marked with the following symbols:

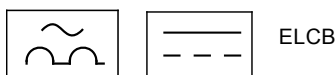

Fig. 31 Circuit breaker type B

The total leakage current of all the electrical equipment in the installation must be taken into account. During start and in asymmetrical supply systems, the leakage current can be higher than normal and may cause the ELCB to trip.

Motor protection

The motor requires no external motor protection. The CU331SP protects the motor against thermal overloading and blocking.

Protection against overcurrent

The CU331SP has an internal overcurrent protection for overload protection on the motor output.

Protection against mains voltage transients

The CU331SP is protected against mains voltage transients according to EN 61800-3, second environment.

Mains and motor connection

The supply voltage and frequency are marked on the CU331SP nameplate. Make sure that the CU331SP is suitable for the power supply of the installation site.

The maximum output voltage of the CU331SP is equal to the input.

Example: if the supply voltage is rated at 208V choose a 208V motor for operation.

Mains switch

A mains switch can be installed before the CU331SP according to local regulations. See fig. 32.

Wiring diagram

The wires in the terminal box must be as short as possible. Excepted from this is the ground wire, which must be so long that it is the last one to be disconnected in case the cable is inadvertently pulled out of the cable entry.

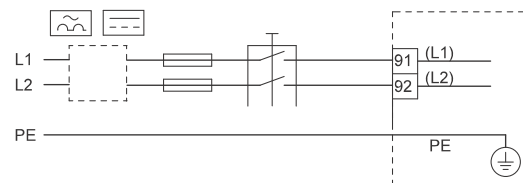

TM05 5867 3912

Fig. 32 CU331SP wiring diagram

Terminal	Function
91 (L1)	Single-phase supply
92 (L2)	
95/99 (PE)	Ground connection

For single-phase connection, use L1 and L2.

Mains connection

Check that mains voltage and frequency correspond to the values on the nameplate of the CU331SP and the motor.

1. Connect the ground wire to terminal 95 (PE). See fig. 33.
2. Connect the power leads to the terminals 91 (L1), 92 (L2).
3. Fix the mains cable with a cable clamp.

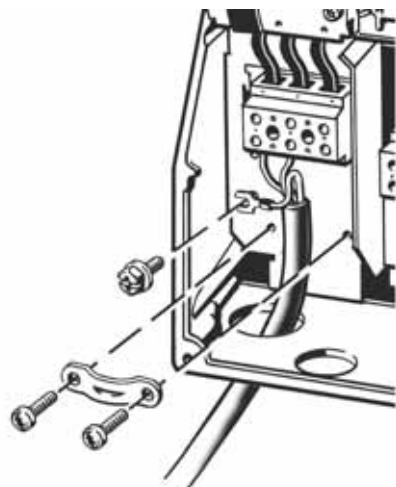

Fig. 33 Mains connection

CU331SP drive is usable with 3-phase input power by connecting leads to 91 (L1), 92 (L2), and 93 (L3).

Motor connection

The motor cable must be screened for the CU331SP to meet EMC requirements.

1. Connect the ground wire to terminal 99 (PE). See fig. 34.
2. Connect the motor leads to the terminals 96 (U), 97 (V), 98 (W).
3. Fix the screened cable with a cable clamp.

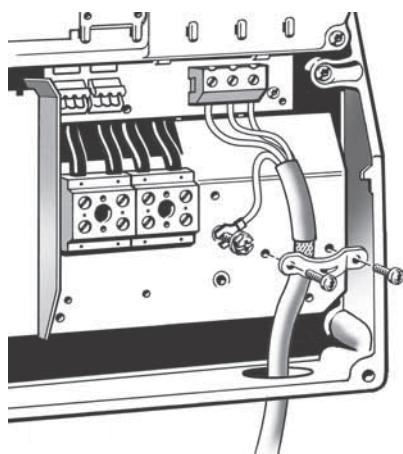

Fig. 34 Motor connection

TM03 9020 2807

The cable screen must be exposed and in physical contact with the mounting plate and clamp

11.1 Connecting the signal terminals

As a precaution, signal cables must be separated from other groups by reinforced insulation in their entire lengths.

If no external on/off switch is connected, short-circuit terminals 18 and 20 using a short wire.

Connect the signal cables according to the guidelines for good practice to ensure EMC-correct installation. See section *EMC-correct installation*.

- Use screened signal cables with a conductor cross-section of min. AWG 20 (0.5 mm²) and max. AWG 16 (1.5 mm²).
- Use a 3-conductor screened bus cable in new systems.

Minimum connection, signal terminal

Operation is only possible when the terminals 18 and 20 are connected, for instance by means of an external on/off switch or a short wire.

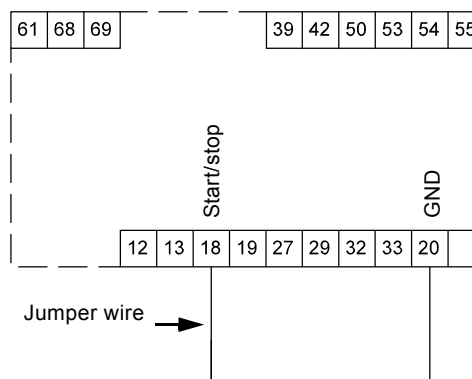

TM03 9057 3207

Fig. 35 Required minimum connection, signal terminal

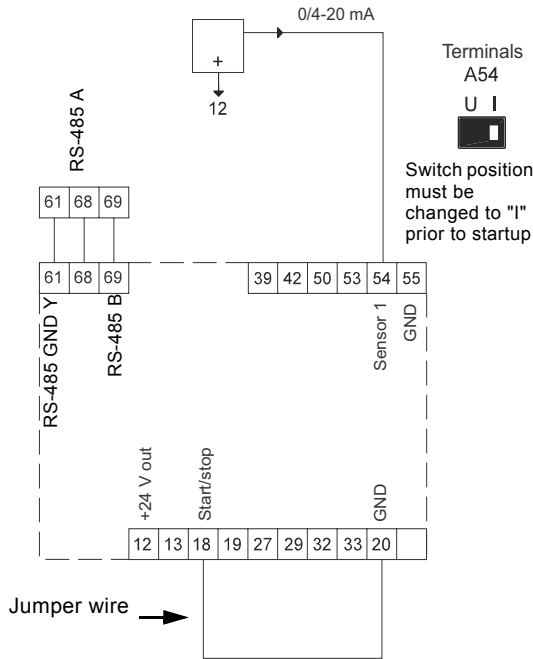

Fig. 36 Wiring diagram for CU331SP

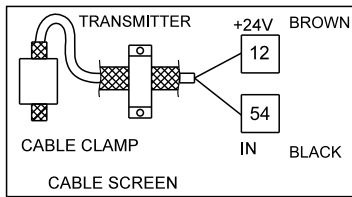

Fig. 37 Sensor wiring diagram

Setting the analog input 54

The contact A54 is positioned behind the control panel and is used for setting the signal type of the analog input.

The factory setting of the inputs is voltage signal "U". This setting must be changed to "I" prior to starting the CU331SP. Be sure the power supply is switched off.

Remove the control panel to set the contact. See fig. 38.

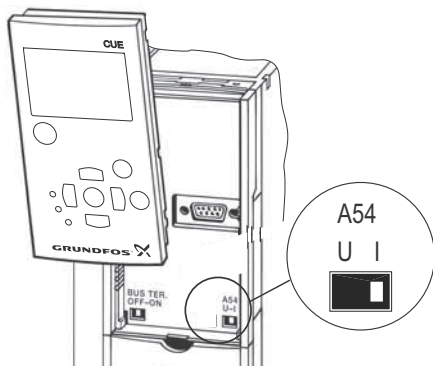

Fig. 38 Setting contact A54 to current signal "I"

Terminal key

Terminal	Type	Function
12	+24 V out	Supply to sensor
18	DI 1	Digital input, start/stop
20	GND	Common frame for digital inputs
55	GND	Common frame for analog inputs
54	AI 2	Sensor input, sensor 1, 0/4-20 mA
61	RS-485 GND Y	GENIbus, frame
68	RS-485 A	GENIbus, signal A (+)
69	RS-485 B	GENIbus, signal B (-)

The RS-485 screen must be connected to frame.

Access to signal terminals

All signal terminals are behind the terminal cover of the CU331SP front. Remove the terminal cover as shown in fig. 39.

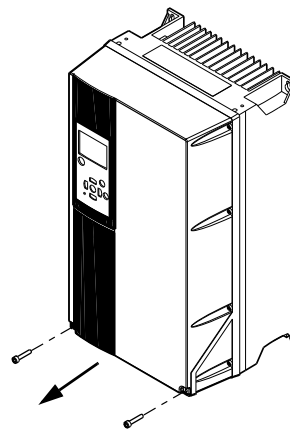

Fig. 39 Access to signal terminals

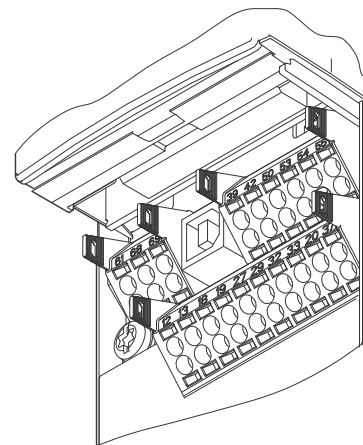

Fig. 40 Signal terminals

TM05 5802 3913

TM05 6776 5112

TM03 9004 2807

TM03 9025 2807

TM05 5803 3912

Fitting the conductor

1. Remove the insulation at a length of 0.35 to 0.40 inches (9 to 10 mm).
2. Insert a screwdriver with a tip of maximum 0.015 X 0.1 in (0.4 X 2.5 mm) into the square hole.
3. Insert the conductor into the corresponding round hole. Remove the screwdriver. The conductor is now fixed in the terminal.

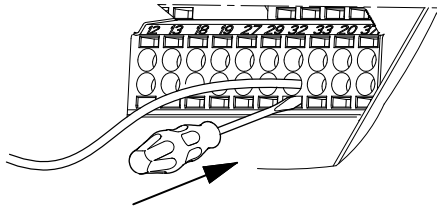
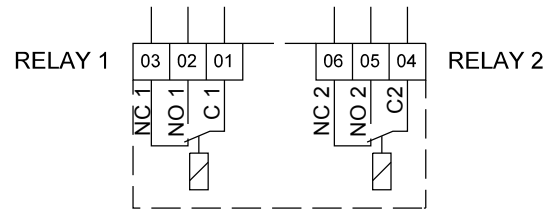

Fig. 41 Fitting the conductor into the signal terminal

TM03 9026 2807

Connecting the signal relays

As a precaution, signal cables must be separated from other groups by reinforced insulation in their entire lengths.



TM03 8801 2507

Fig. 42 Terminals for signal relays (normal state, not activated)

Terminal	Function
C 1 C 2	Common
NO 1 NO 2	Normally open contact
NC 1 NC 2	Normally closed contact

Signal relay

The signal relays on the CU331SP are predefined as follows:

- Relay 1: Pump running
- Relay 2: Alarm

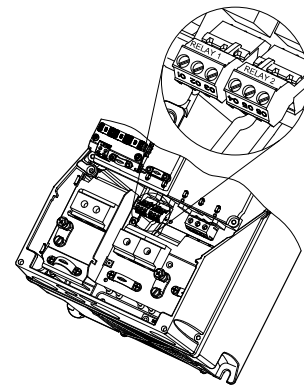

TM03 9008 2807

Fig. 43 Terminals for relay connection

EMC-correct installation

This section gives guidelines for good practice when installing the CU331SP. Follow these guidelines to meet EN 61800-3, first environment.

- Use only motor and signal cables with a braided metal screen in applications without output filter.
- There are no special requirements to supply cables, apart from local requirements.
- Leave the screen as close to the connecting terminals as possible. See fig. 44.
- Avoid terminating the screen by twisting the ends. See fig. 45. Use cable clamps or EMC screwed cable entries instead.
- Connect the screen to frame at both ends for both motor and signal cables. If the controller has no cable clamps, connect only the screen to the CU331SP.
- Avoid unscreened motor and signal cables in electrical cabinets with variable frequency drives.
- Make the motor cable as short as possible in applications without output filter to limit the noise level and minimize leakage currents.
- Screws for frame connections must always be tightened whether a cable is connected or not.
- Keep main cables, motor cables and signal cables separated in the installation, if possible.

Other installation methods may give similar EMC results if the above guidelines for good practice are followed.

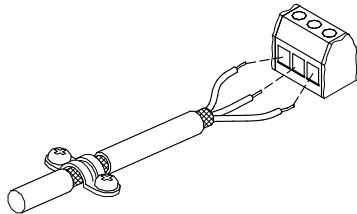

Fig. 44 Example of stripped cable with screen

TM02 1325 0901

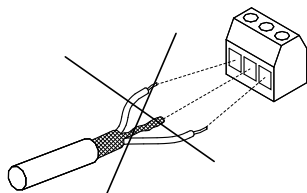

Fig. 45 Do not twist the screen ends

TM03 8812 2507

Line disturbance and transient protection

To protect itself from AC line voltage disturbances, the CU331SP monitors the input power supply and interrupts drive operation in the event of phase loss or imbalance. Transients on the AC line are suppressed by MOVs as well as zener diodes for extreme transients. The CU331SP meets VDE 0160 (European standard - 2.3 x line voltage for 1.3 msec) for transient protection.

RFI filters

To meet the EMC requirements, the CU331SP comes with the following types of built-in radio frequency interference filter (RFI).

Voltage	Typical shaft power P2	RFI filter type
1 x 200-240 V *	1.5 - 10 hp	C1

*Single-phase input - three-phase output.

Description of RFI filter types

C1: For use in domestic areas.

RFI filter types are according to EN61800-3

Control panel

The on/off button on the control panel does not disconnect the CU331SP from the power supply and must therefore not be used as a safety switch.



The On/Off button has the highest priority. In "Off" condition, pump operation is not possible.

The control panel is used for local setting of the CU331SP. The functions available are preset in the CU331SP.

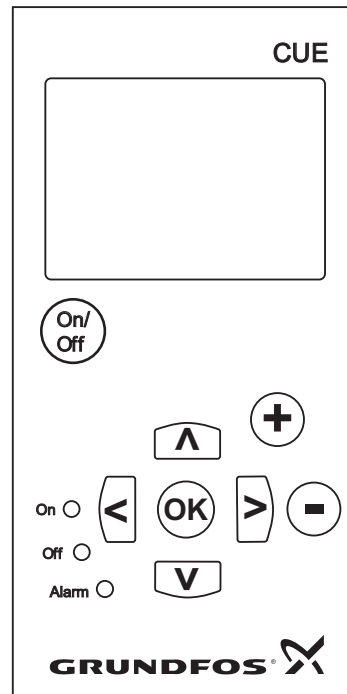



Fig. 46 Control panel of the CU331SP

TM03 8719 2507

Editing buttons

Button	Function
	Makes the pump ready for operation/starts and stops the pump.
	Saves changed values, resets alarms and expands the value field.
	Changes values in the value field.

Navigating buttons

Button	Function
	Navigates from one menu to another. When the menu is changed, the display shown will always be the top display of the new menu.
	Navigates up and down in the individual menu.

Adjusting the display contrast

Press OK and + for darker display.

Press OK and - for brighter display.

Button lock

To lock the buttons on the panel press and hold the up and down arrows simultaneously.

Indicator lights

The operating condition of the pump is indicated by the indicator lights on the front of the control panel. See fig. 46.

The table shows the function of the indicator lights.

Indicator light	Function
On (green)	The pump is running or has been stopped by a stop function. If flashing, the pump has been stopped by the user (CU331SP menu), external start/stop or bus.
Off (orange)	The pump has been stopped with the on/off button.
Alarm (red)	Indicates an alarm or a warning.

Displays, general terms

Figures 47 and 48 show the general terms of the display.

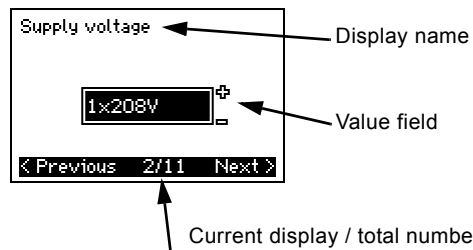

Fig. 47 Example of display in the start-up guide

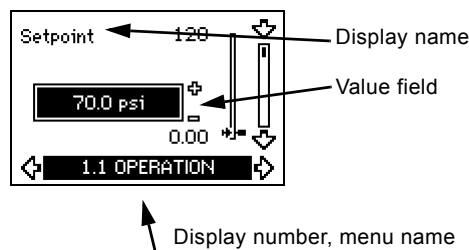

Fig. 48 Example of display in the user menu

Warning and alarm list

Code and display text	Status			Operating mode	Resetting
	Warning	Alarm	Locked alarm		
1 Too high leakage current			•	Stop	Man.
2 Mains phase failure		•		Stop	Aut.
3 External fault		•		Stop	Man.
16 Other fault			•	Stop	Man.
32 Overvoltage	•			-	Aut.
40 Undervoltage	•			-	Aut.
48 Overload		•		Stop	Aut.
49 Overload		•	•	Stop	Man.
55 Overload	•			-	Aut.
57 Dry running		•		Stop	Aut.
64 Too high CU331SP temperature		•		Stop	Aut.
89 Sensor 1 outside range		•		1)	Aut.
96 Setpoint signal outside range		•		1)	Aut.
155 Inrush fault		•		Stop	Aut.
241 Motor phase failure	•			-	Aut.
			•	Stop	Aut.

1) In case of an alarm, the CU331SP will change the operating mode depending on the pump type.

2) Warning is reset in display 3.20.

CU331SP technical data

Enclosure

All CU331SP enclosures are size B1.

The enclosure rating can be either IP 55 / TYPE 12 or IP 66 / TYPE 4X.

Main dimensions and weight

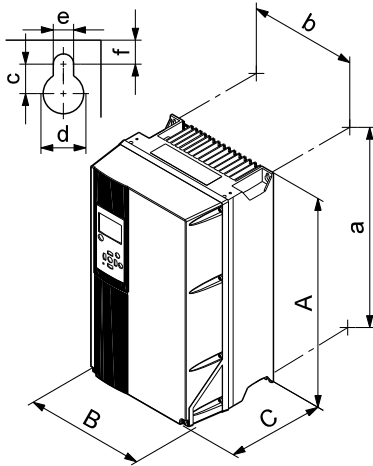

TM03 9002 2807

Fig. 49 Enclosure B1

1) The dimensions are maximum height, width and depth.

Enclosure	Height [in]		Width [in]		Depth [in]
	A	a	B	b	C
B1	18.9	17.9	9.5	8.3	10.2
	Screw holes [in]				Weight [lbs]
c	d	e	f	50.7	

Surroundings

Relative humidity	5-95 % RH
Ambient temperature	Max. 122 °F (50 °C)
Average ambient temperature over 24 hours	Max. 113 °F (45 °C)
Minimum ambient temperature at full operation	32 °F (0 °C)
Minimum ambient temperature at reduced operation	14 °F (-10 °C)
Temperature during storage and transportation	-13 to 150 °F (-25 to 65 °C)
Storage duration	Max. 6 months
Maximum altitude above sea level without performance reduction	3280 ft (1000 m)
Maximum altitude above sea level with performance reduction	9840 ft (3000 m)

The CU331SP comes in a packaging which is not suitable for outdoor storage.

Terminal tightening torques

Enclosure	Tightening torque [ft-lb]			
	Mains	Motor	Earth	Relay
B1	1.3	1.3	2.2	0.4

Cable length

Maximum length, screened motor cable	500 ft (152 m)
Maximum length, unscreened motor cable	1000 ft (305 m)
Maximum length, signal cable	1000 ft (305 m)

Fuses and cable cross-section

Always comply with national and local regulations as to cable cross-sections.

Cable cross-section to signal terminals

Maximum cable cross-section to signal terminals, rigid conductor	AWG 14
Maximum cable cross-section to signal terminals, flexible conductor	AWG 18
Minimum cable cross-section to signal terminals	AWG 20

Non-UL fuses and conductor cross-section to mains and motor

Typical shaft power P2 [Hp]	Maximum fuse size [A]	Fuse type	Maximum conductor cross section ¹	
			[AWG]	[mm ²]
2	40	gG	7	10
3	40	gG	7	10
5	80	gG	7	10

1) Screened motor cable, unscreened supply cable.

UL fuses and conductor cross-section to mains and motor

Typical shaft power P2 [Hp]	Maximum fuse size [A]	Bussmann RK1	Maximum conductor cross section ¹
			[AWG]
2	40	KTN-R40	7
3	40	KTN-R40	7
5	80	KTN-R80	7

1) Screened motor cable, unscreened supply cable.

Inputs and outputs

Mains supply (L1, L2)

Supply voltage	200-240 V ± 10 %
Supply frequency	60 Hz
Maximum temporary imbalance between phases	3 % of rated value
Leakage current to earth	> 3.5 mA
Number of cut-ins	Max. 1 time/min.

Do not use the power supply for switching the CU331SP on and off.

Motor output (U, V, W)

Output voltage	0-100 % ¹⁾
Output frequency	0-60 Hz
Switching on output	Not recommended

¹⁾ Output voltage in % of supply voltage.

RS-485 GENibus connection

Terminal number	68 (A), 69 (B), 61 GND (Y)
-----------------	----------------------------

The RS-485 circuit is functionally separated from other central circuits and galvanically separated from the supply voltage (PELV).

Digital inputs

Terminal number	18
Voltage level	0-24 VDC
Voltage level, open contact	> 19 VDC
Voltage level, closed contact	< 14 VDC
Maximum voltage on input	28 VDC
Input resistance, R_i	Approx. 4 k Ω

All digital inputs are galvanically separated from the supply voltage (PELV) and other high-voltage terminals.

Signal relays

Relay 01 , terminal number	1 (C), 2 (NO), 3 (NC)
Relay 02 , terminal number	4 (C), 5 (NO), 6 (NC)
Maximum terminal load (AC-1) ¹⁾	240 VAC, 2 A
Maximum terminal load (AC-15) ¹⁾	240 VAC, 0.2 A
Maximum terminal load (DC-1) ¹⁾	50 VDC, 1 A
Minimum terminal load	24 V DC 10 mA 24 V AC 20 mA

¹⁾ IEC 60947, parts 4 and 5.

- C Common
- NO Normally open
- NC Normally closed

The relay contacts are galvanically separated from other circuits by reinforced insulation (PELV).

Analog input

Terminal number	54
Current signal	A54 = "I" ¹⁾
Current range	0-20, 4-20 mA
Input resistance, R_i	Approx. 200 Ω
Maximum current	30 mA
Maximum fault, terminals 53, 54	0.5 % of full scale

¹⁾ The factory setting is voltage signal "U".

All analog inputs are galvanically separated from the supply voltage (PELV) and other high-voltage terminals.

Sound pressure level

The sound pressure of the CU331SP is maximum 70 dB(A).

The sound pressure level of a motor controlled by a Variable frequency drive may be higher than that of a corresponding motor which is not controlled by a variable frequency drive.

CU331SP curve charts

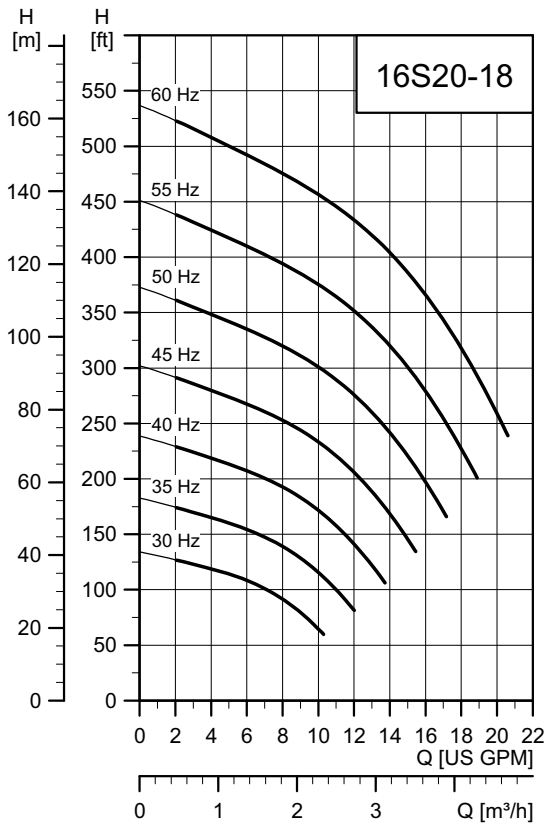
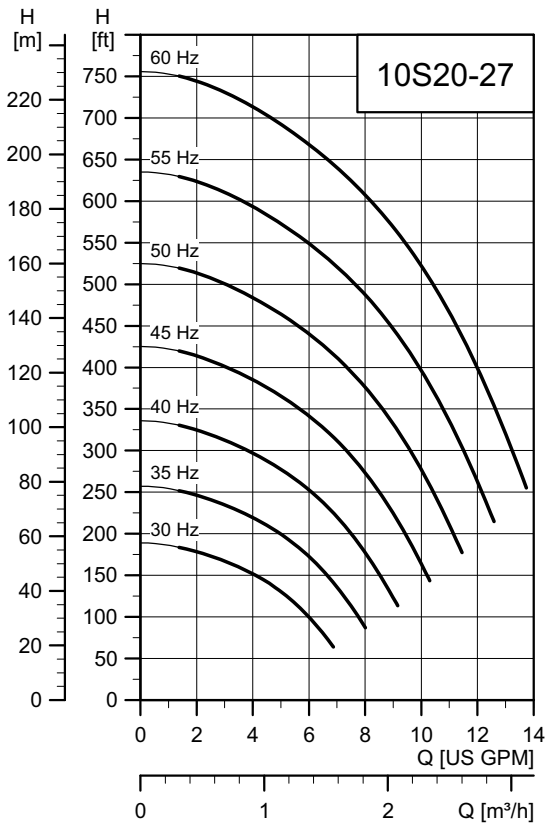
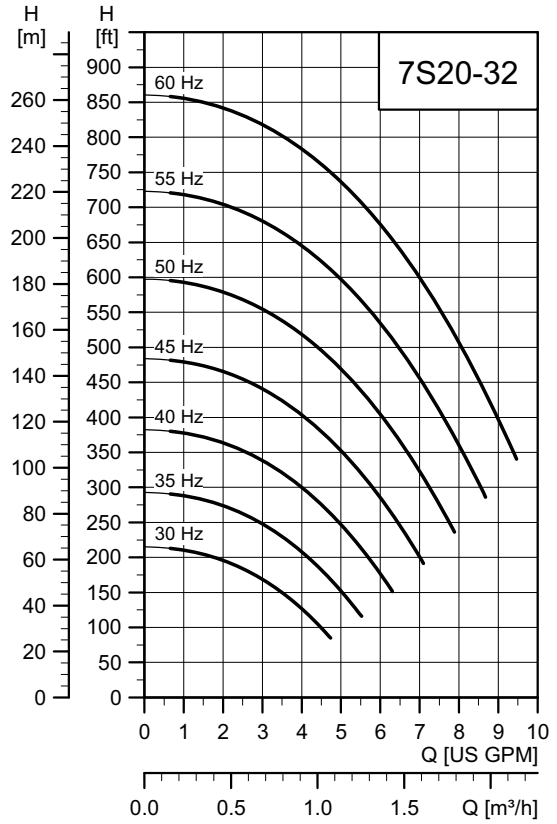
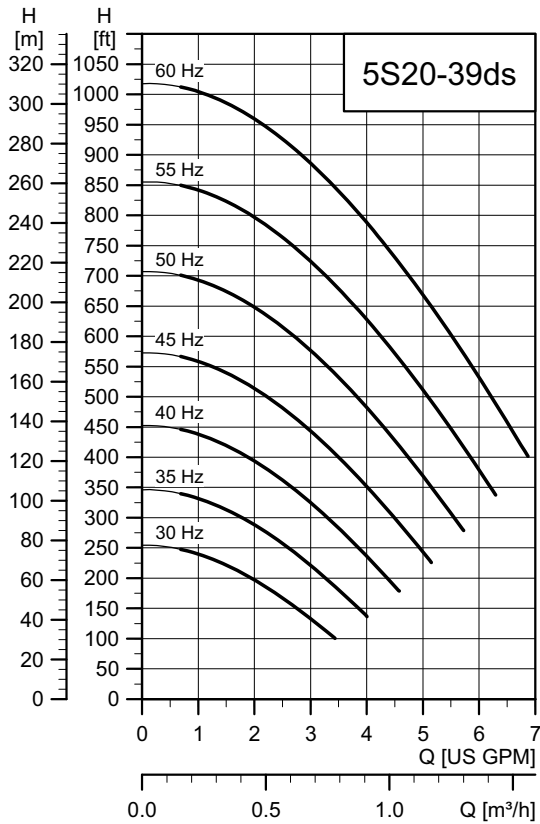

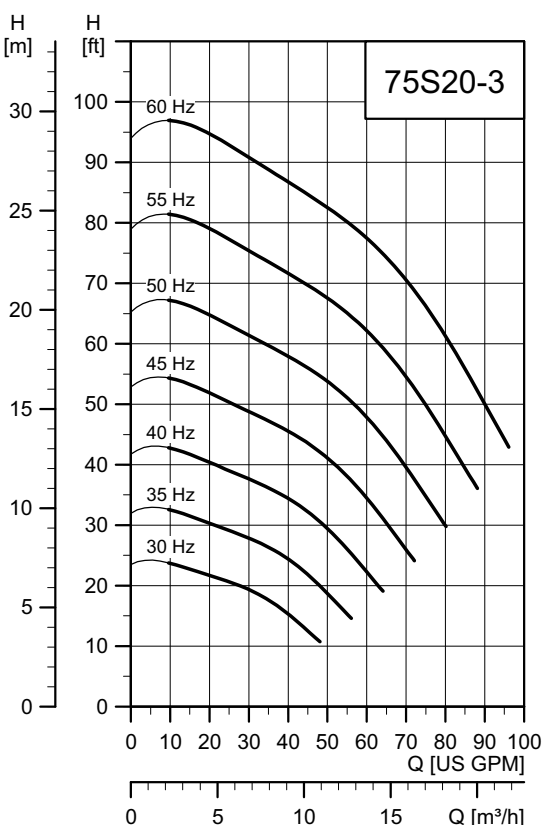
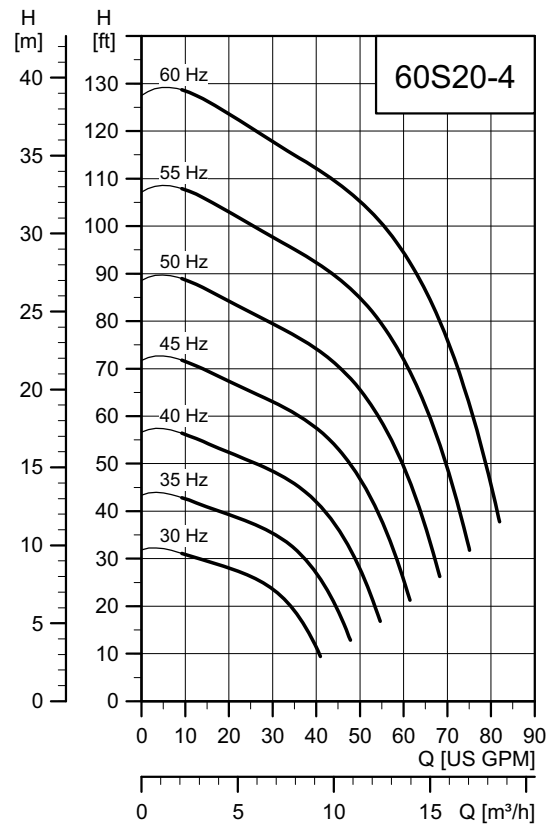
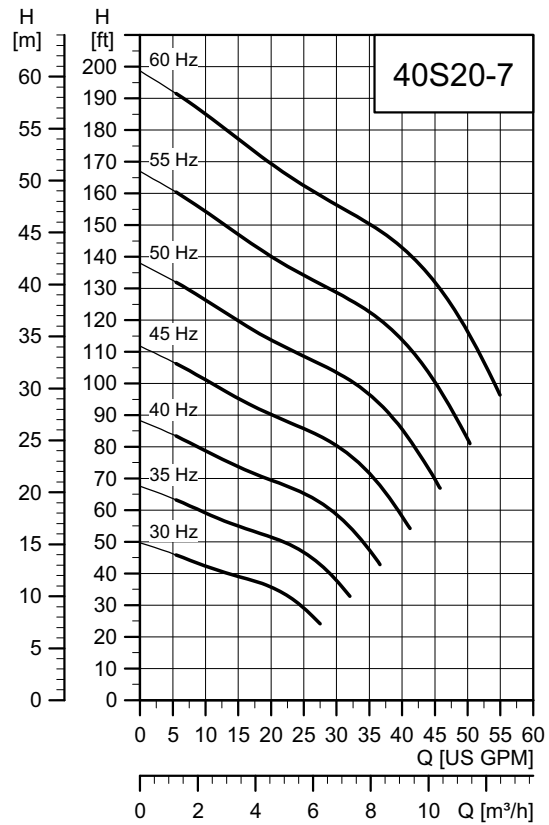
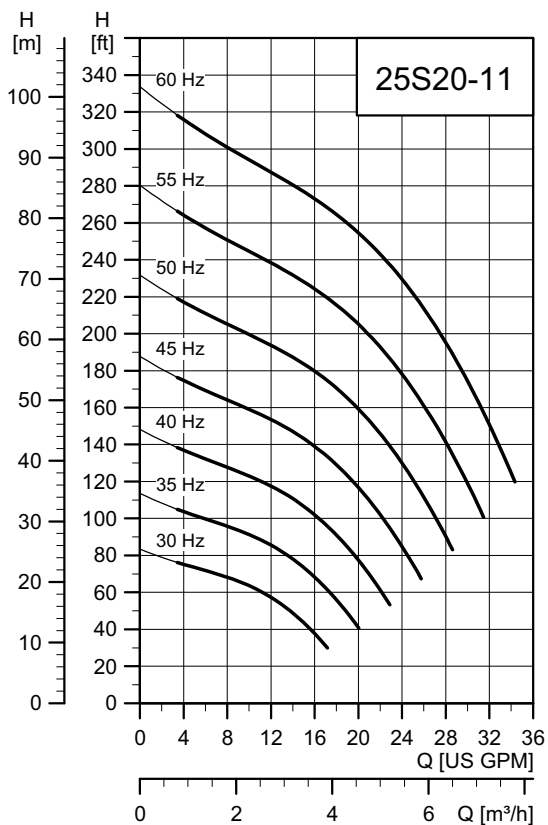

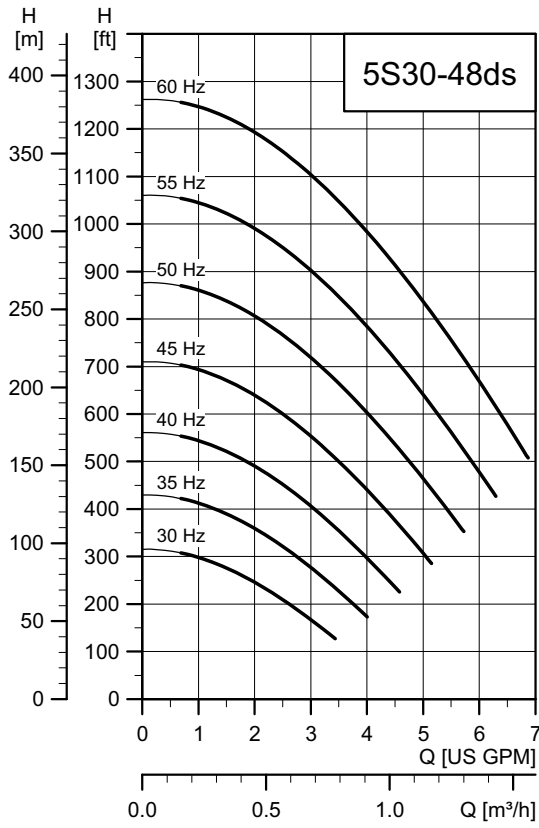

TM05 6418 5012

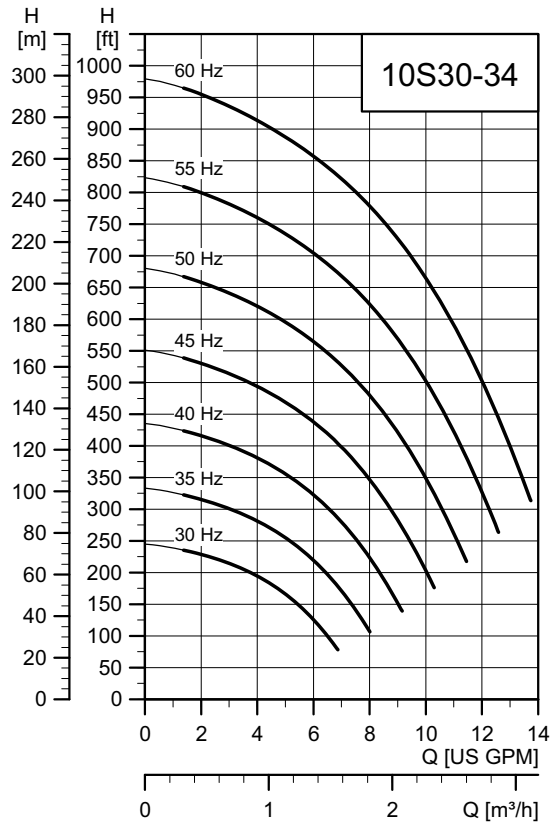

TM05 6419 5012

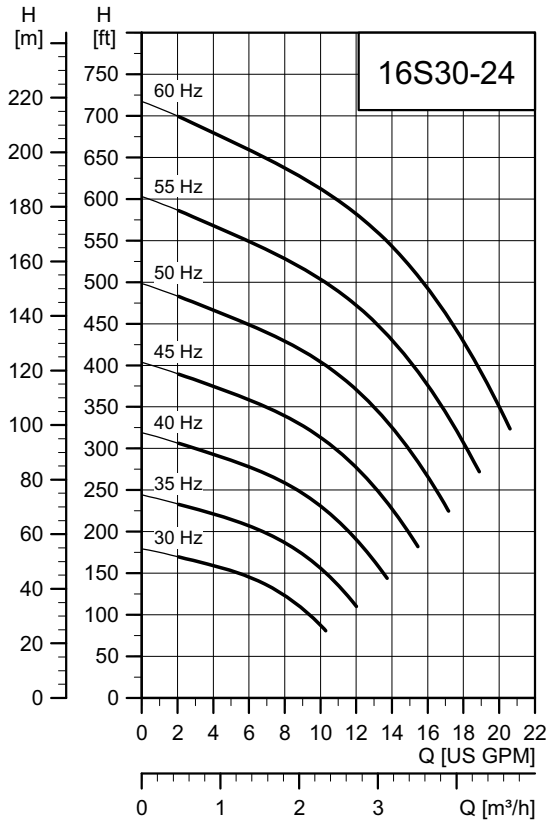

TM05 6420 5012

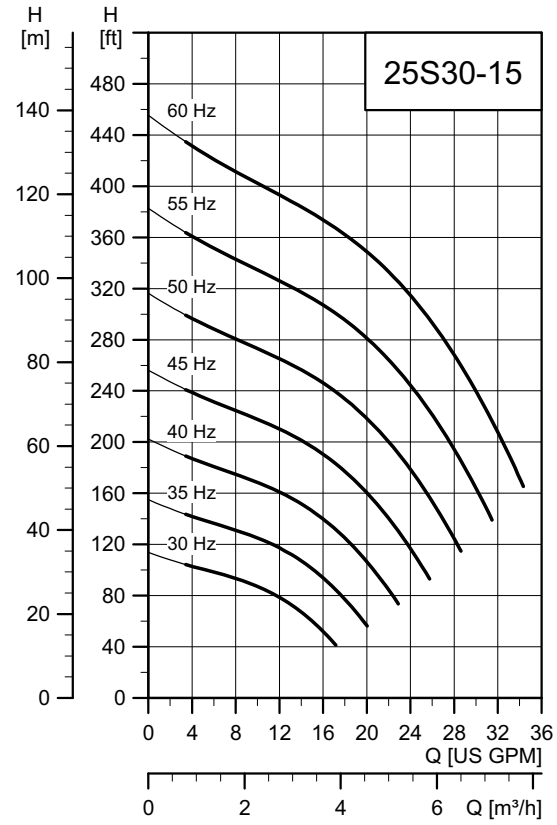

TM05 6421 5012

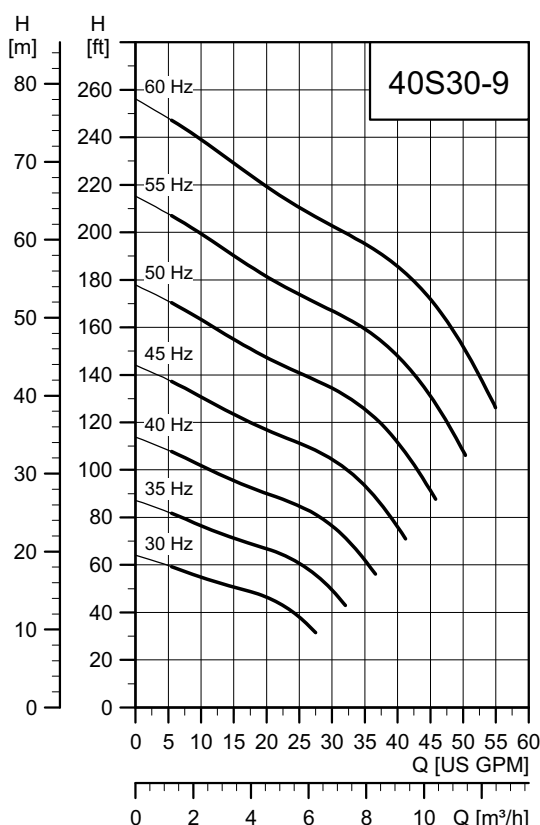

TM05 6422 5012

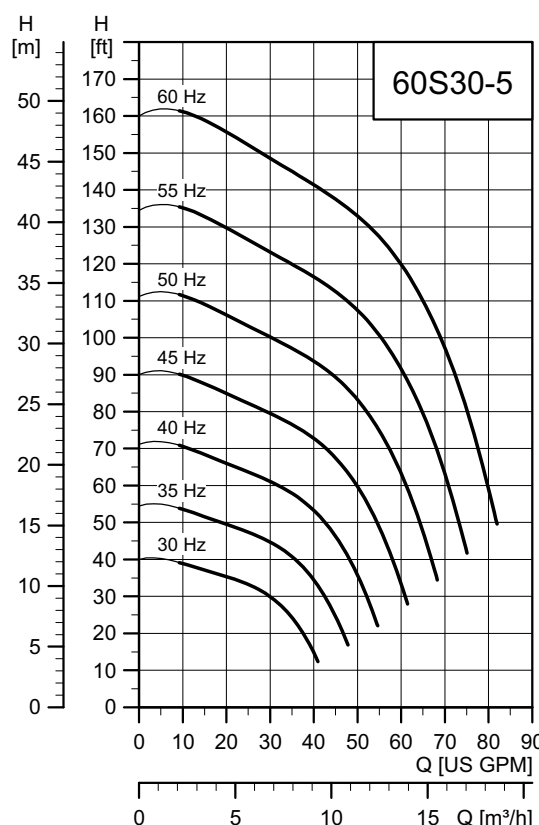

TM05 6423 5012

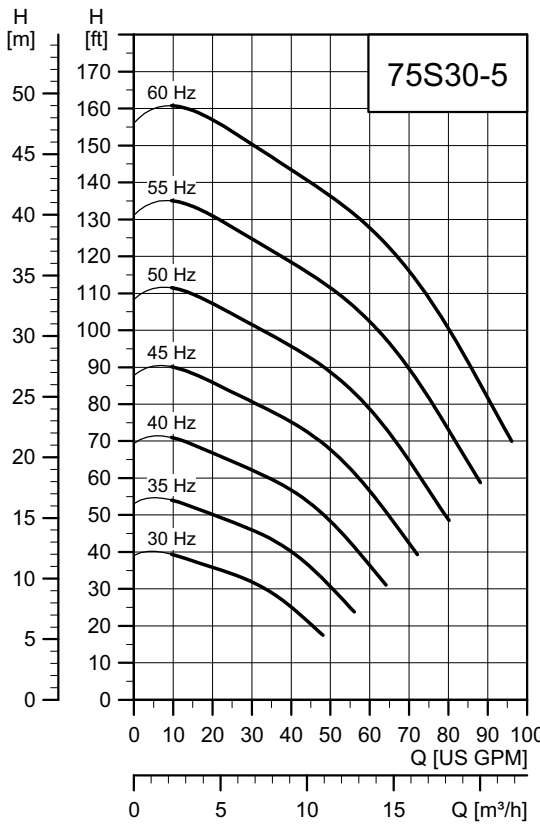

TM05 6424 5012

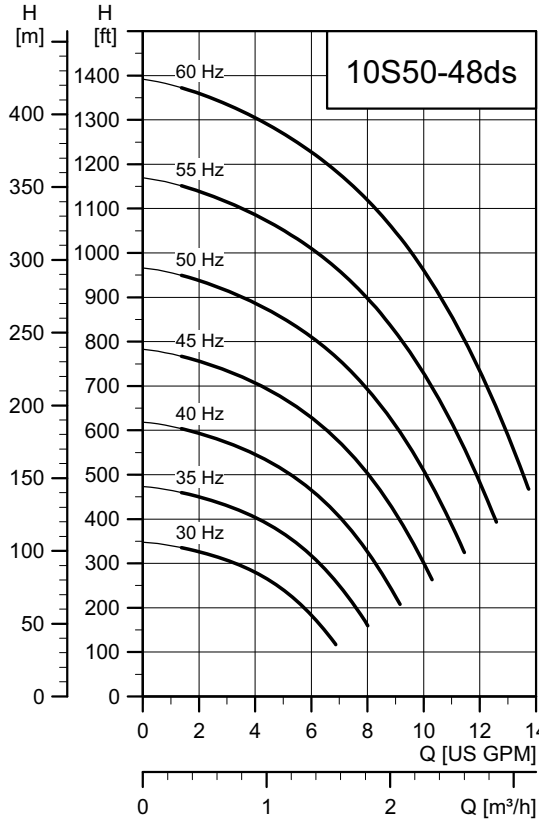

TM05 6425 5012

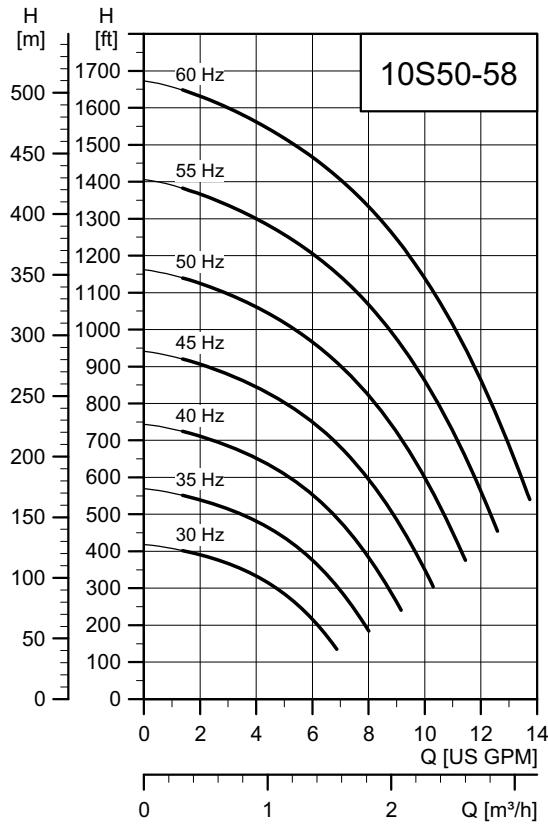

TM05 6426 5012

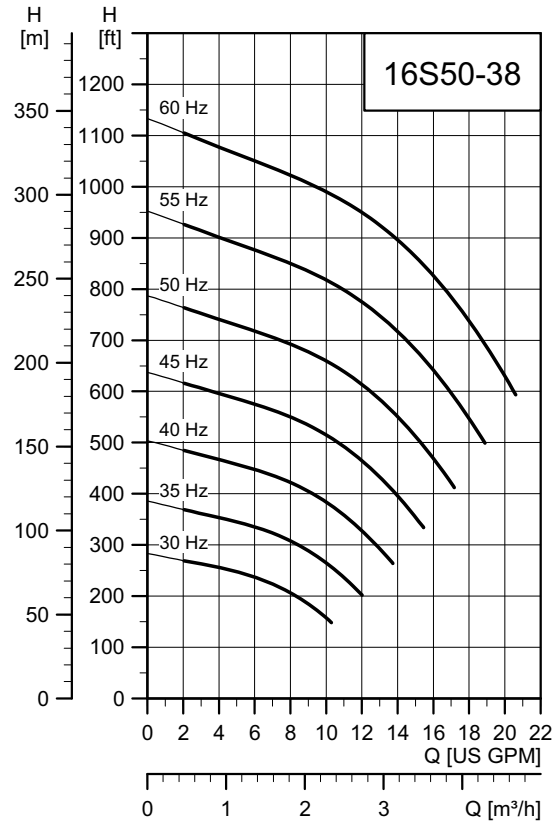

TM05 6427 5012

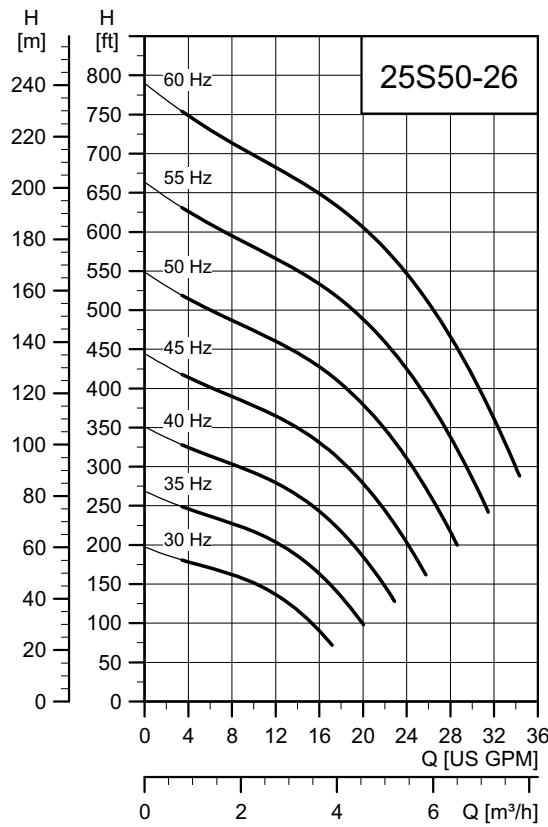

TM05 6428 5012

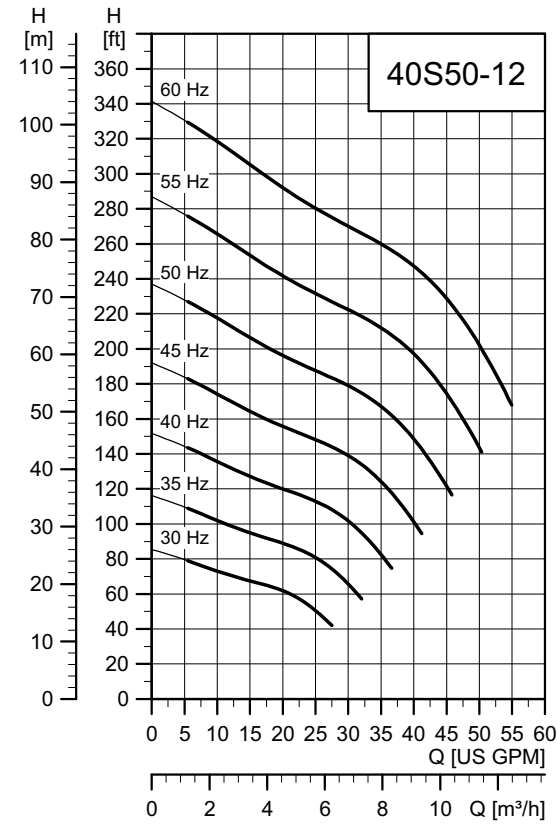

TM05 6429 5012

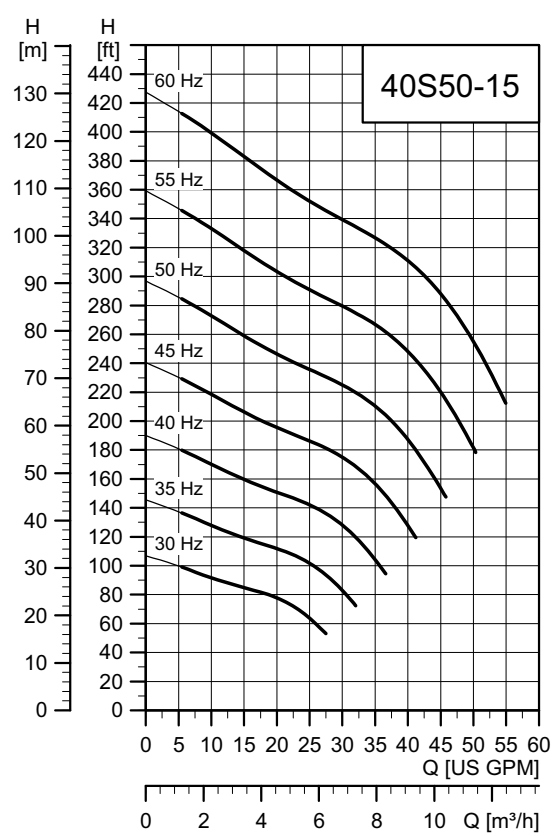

TM05 6430 5012

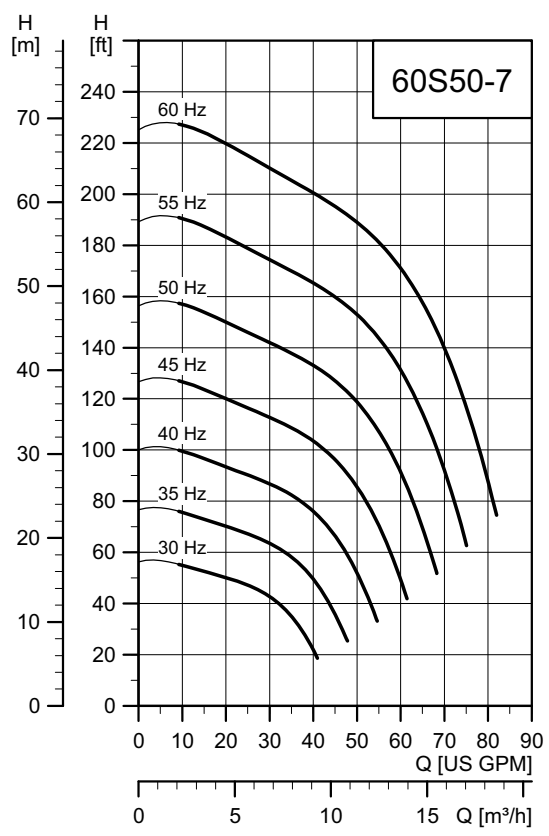

TM05 6431 5012

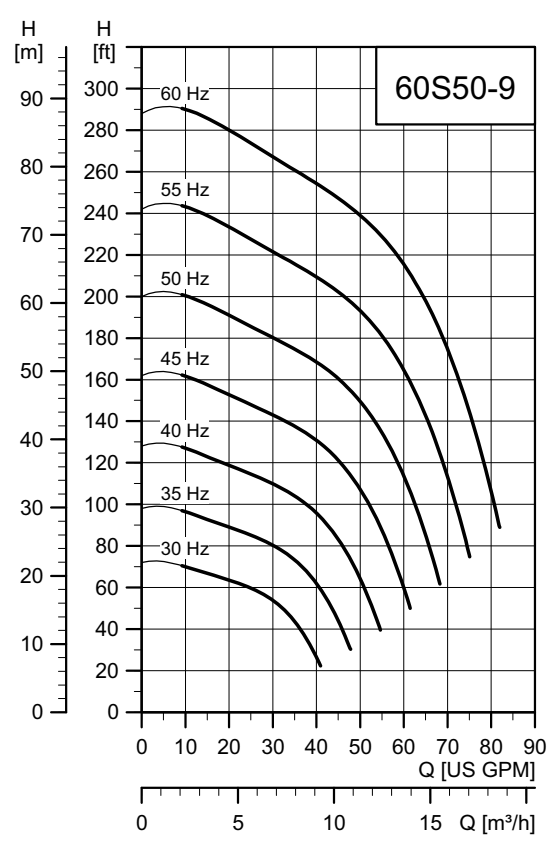

TM05 6432 5012

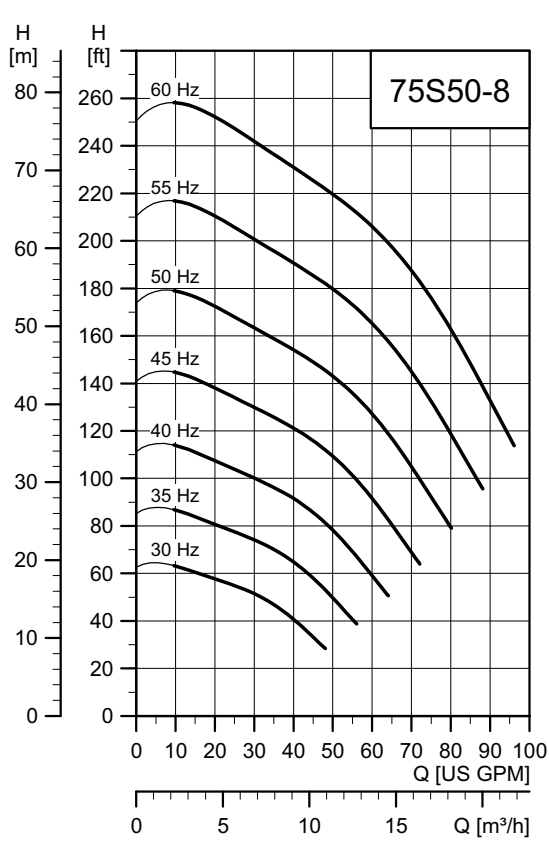

TM05 6433 5012

12. Accessories

CU331SP Constant Pressure Drive Kits (with sensor)



TM05 5801 4012

Enclosure type	NEMA	Hp	Input Ph	Input volts	Product number	Approx. ship wt. [lbs]
Indoor	Type 12	2	1	200 - 240	98370277	60
		3	1	200 - 240	98370280	60
		5	1	200 - 240	98370304	60
Outdoor	Type 4X	2	1	200 - 240	98370279	60
		3	1	200 - 240	98370301	60
		5	1	200 - 240	98370305	60

CU 301 Constant Pressure System



TM04 7509 2110

Description	Product number
Constant Pressure Kit (CU 301 and Transducer)	96438895

CU 300 Status Box & R100



TM04 7508 2110

Description	Product number
CU300 Status Box	96422776
Description	Product number
R100 (for wireless infrared communication with the CU 301 / CU 300)	96615297

SQ, SQE flow sleeves

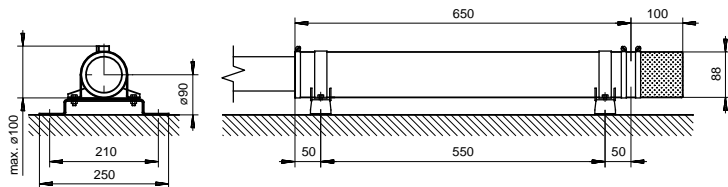

TM01 3292 3798

Description	Product number
SQ, SQE flow sleeve, complete	98148594

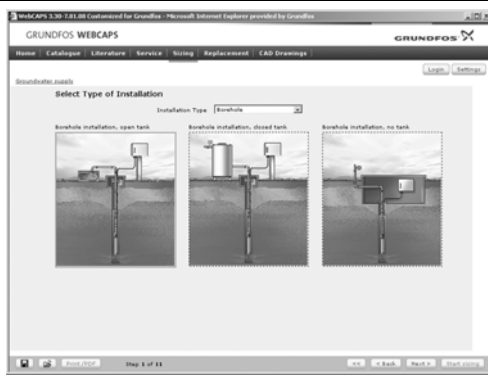

Sizing

This section is based on different fields of application and installation examples, and gives easy step-by-step instructions in how to

- select the most suitable and efficient pump for your installation
- carry out advanced calculations based on energy consumption, payback periods, load profiles, life cycle costs, etc.
- analyse your selected pump via the built-in life cycle cost tool
- determine the flow velocity in wastewater applications, etc.



Replacement

In this section you find a guide to selecting and comparing replacement data of an installed pump in order to replace the pump with a more efficient Grundfos pump. The section contains replacement data of a wide range of pumps produced by other manufacturers than Grundfos.

Based on an easy step-by-step guide, you can compare Grundfos pumps with the one you have installed on your site. When you have specified the installed pump, the guide will suggest a number of Grundfos pumps which can improve both comfort and efficiency.



CAD drawings

In this section it is possible to download 2-dimensional (2D) and 3-dimensional (3D) CAD drawings of most Grundfos pumps.

These formats are available in WebCAPS:

2-dimensional drawings:

- .dxf, wireframe drawings
- .dwg, wireframe drawings.

3-dimensional drawings:

- .dwg, wireframe drawings (without surfaces)
- .stp, solid drawings (with surfaces)
- .eprt, E-drawings.

WinCAPS



Fig. 50 WinCAPS CD-ROM

WinCAPS is a **Windows-based Computer Aided Product Selection** program containing detailed information on more than 185,000 Grundfos products in more than 20 languages.

The program contains the same features and functions as WebCAPS, but is an ideal solution if no Internet connection is available.

WinCAPS is available on CD-ROM and updated once a year.

L-SQ-PG-001

98440904 0313

ECM: -

GRUNDFOS Pumps Corporation

17100 West 118th Terrace
Olathe, Kansas 66061
Phone: +1-913-227-3400
Telefax: +1-913-227-3500

GRUNDFOS Canada Inc.

2941 Brighton Road
Oakville, Ontario L6H 6C9
Canada
Phone: +1-905 829 9533
Telefax: +1-905 829 9512

Bombas GRUNDFOS de Mexico S.A. de C.V.

Boulevard TLC No. 15
Parque Industrial Stiva Aeropuerto
Apodaca, N.L. Mexico 66600
Phone: +52-81-8144 4000
Telefax: +52-81-8144 4010

GRUNDFOS 